

# Beamex® POC6 AUTOMATIC PRESSURE CONTROLLER



## User Guide

Version 1.1

Dear user,

We have made every effort to ensure the accuracy of the contents of this manual. Should any errors be detected, we would greatly appreciate to receive suggestions to improve the quality of the contents of this manual.

The above notwithstanding, we can assume no responsibility for any errors in this manual or their eventual consequences.

We reserve rights to make modifications to this manual without any further notice.

For more detailed technical data about the Beamex® POC6 Automatic Pressure Controller, please contact the manufacturer.

© Copyright 2008-2009

**BEAMEX OY AB**

**Ristisuonraitti 10**

**FIN-68600 Pietarsaari**

**FINLAND**

**Tel +358 - 10 - 5505000**

**Fax +358 - 10 - 5505404**

**E-mail: sales@beamex.com**

**Internet: http://www.beamex.com**

8889750 / UEPOC6 / 111701



**Warning**

**This Warning symbol indicates that danger of injury for persons and the environment and/or considerable material damage (mortal danger, danger of injury) will occur if the respective safety precautions are not taken.**



**Caution**

**This Caution symbol indicates danger for the system and material if the respective safety precautions are not taken.**



**Notice**

**This Notice symbol does not indicate safety notices but information for a better understanding of the facts.**

# Contents

<b>1</b>	<b>General Information.....</b>	<b>1</b>
1.1	FCC Radio Frequency Emission notice.....	1
1.2	Trademarks and Copyrights.....	1
1.3	Packaging for Shipment.....	1
<b>2</b>	<b>Safety Notices.....</b>	<b>2</b>
2.1	User Responsibilities.....	2
2.2	General Safety Notices.....	3
2.3	Warnings and Caution Notices.....	3
<b>3</b>	<b>Product description.....</b>	<b>5</b>
3.1	Proper Use.....	5
3.2	Features.....	6
3.3	Turning on POC6.....	7
3.4	Front Panel.....	7
3.5	Main Menu.....	8
3.5.1	Keys, Tabs, Check Boxes, Labels/Graphics.....	8
3.6	Front Panel Variations and Navigation.....	9
3.6.1	Operating mode.....	9
3.7	Main Menu Setpoint Entry Options.....	11
<b>4</b>	<b>Specifications.....</b>	<b>12</b>
<b>5</b>	<b>Installation.....</b>	<b>13</b>
5.1	Introduction.....	13
5.2	Unpacking and Inspection.....	13
5.3	Dimensions in mm.....	13
5.4	Installation.....	14
5.5	Rear Panel.....	15
5.6	Pressure Connections.....	15
5.7	Function of Pressure Connections.....	16
5.8	Electrical Connections.....	17
5.8.1	Connecting the Power Supply and Turning On the Instrument.....	17

5.8.2	Connecting the Communications Interfaces .....	17
<b>6</b>	<b>Starting Operation .....</b>	<b>18</b>
<b>7</b>	<b>Local Operation .....</b>	<b>19</b>
7.1	Setting the Operating Language .....	19
7.2	Display Configuration .....	19
7.3	Setpoint Entry .....	21
7.4	Operating Modes .....	23
7.5	Data Entry .....	26
7.6	"Pressure Unit", "Pressure Mode" and "Emulation Mode" .....	26
7.7	Bar Chart.....	27
7.8	Setup Menus.....	27
7.8.1	Setup Display .....	28
7.8.2	Setup Control .....	29
7.8.3	Setup Remote .....	30
7.8.4	Setup Info.....	31
7.8.5	Setup Service .....	31
<b>8</b>	<b>Remote Operation .....</b>	<b>35</b>
8.1	Remote Setup.....	36
8.2	Remote Setup – Ethernet .....	36
8.3	Remote Setup – USB.....	37
8.4	Remote Setup – IEEE-488.....	37
<b>9</b>	<b>Troubleshooting Measures.....</b>	<b>38</b>
9.1	Fault Description and Measures .....	38
<b>10</b>	<b>Re-calibrating and Servicing .....</b>	<b>40</b>
<b>11</b>	<b>Removal of the Instrument .....</b>	<b>41</b>
<b>12</b>	<b>Transport of the System .....</b>	<b>42</b>
<b>13</b>	<b>Storage of the System.....</b>	<b>43</b>
<b>14</b>	<b>Placing Out of Service .....</b>	<b>44</b>
<b>15</b>	<b>Appendix.....</b>	<b>45</b>
15.1	Measurement Units.....	46
15.2	Conversion Factors, Pascal .....	47

# Feedback

We want to improve our products and services constantly. Therefore we'd like to know Your opinion of the product You use. Please spend a moment of Your valuable time in filling this form. All respondents will receive a surprise gift in return.

Certain questions can be answered immediately after receiving the product. Others require some use of the product before You are able to answer them. The best way to fill the form is to answer the items as it applies, and send the form to us when all items are answered. There are however no definite restrictions; fill in the form when you feel like it (all items need not be answered). Then send it to Beamex using one of the possibilities listed below.

Mail: **Beamex Oy, Ab**  
**Quality Feedback**  
**P.O. Box 5**  
**68601 Pietarsaari**  
**FINLAND**

Fax **+358 - 10 - 5505404**  
*Only the next page need to be faxed to us.*

Internet: **<http://www.beamex.com>**  
*A similar form is available as a web page*

E-mail: **[support@beamex.com](mailto:support@beamex.com)**  
*Refer to the numbered items on the next page in Your e-mail message.*

1. Name of the product you give feedback of: \_\_\_\_\_
2. Serial number and software version number (if applicable) \_\_\_\_\_

3. Any comments when receiving the product. Did the package contain all required items and was it as expected?  
 \_\_\_\_\_  
 \_\_\_\_\_

4. For how long have you been using the product? \_\_\_\_\_

5. How helpful was the manual in using the product?  
 (Tick a box in the percentage scale below)

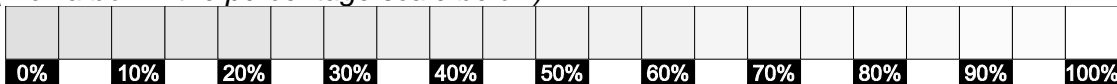

6. How well did the product suit your needs?  
 \_\_\_\_\_  
 \_\_\_\_\_

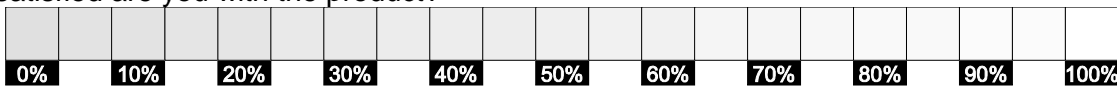

7. How satisfied are you with the product?  
 \_\_\_\_\_  
 \_\_\_\_\_

8. Did anything in the product exceed your expectations? In that case, what was it?  
 \_\_\_\_\_  
 \_\_\_\_\_

9. Did anything in the product disappoint you? In that case, please specify.  
 \_\_\_\_\_  
 \_\_\_\_\_

10. Any ideas You want to propose to Beamex so that we can improve our products, operations and/or services.  
 \_\_\_\_\_  
 \_\_\_\_\_

Please fill in these fields in order to receive your surprise gift.

Title & Name:  
 \_\_\_\_\_

Address:  
 \_\_\_\_\_  
 \_\_\_\_\_  
 \_\_\_\_\_

- Please contact me concerning the Feedback I have given.
- I want to receive more information on Beamex products.

Size (tick one)  
XS S M L XL XXL

# 1 General Information

---

## 1.1 FCC Radio Frequency Emission notice

This equipment has been tested and found to comply with the limits for a Class A digital device, pursuant to Part 15 of the FCC Rules. These limits are designed to provide reasonable protection against harmful interference when the equipment is operated in a commercial environment. This equipment generates, uses, and can radiate radio frequency energy and, if not installed and used in accordance with the instruction manual, may cause harmful interference to radio communications. Operation of this equipment in a residential area is likely to cause harmful interference in which case the user will be required to correct the interference at his or her own expense.

Use shielded cables to connect external devices to this instrument to minimize RF radiation.

---

## 1.2 Trademarks and Copyrights

Beamex is a registered trade mark of Beamex Oy Ab. © 2009. All rights reserved.

---

## 1.3 Packaging for Shipment

If the product must be shipped to a different location or returned to Beamex for any reason through a common carrier it must be packaged properly to minimize the risk of damage.

The recommended method of packing is to place the instrument in a container, surrounded on all sides with at least four inches of shock attenuation material such as styrofoam peanuts.

## 2 Safety Notices

---

### 2.1 User Responsibilities

To ensure safety, the user must make sure that:

- The system is used properly (refer to "Proper use" in the section "Product description"), no dangerous media are used and that all technical specifications are observed.
- Safety mechanisms exist, which exclude any danger to persons or machinery through improper pressurization.
- The system is operated in perfect operating condition.
- This operation manual is legible and accessible to the user at the system's location.
- The system is operated, serviced and repaired only by staff who are authorized and qualified to do so.
- The operator receives instruction on industrial safety and environmental protection, and is knowledgeable of the operating instructions and the safety notices contained therein.



---

## 2.2 General Safety Notices



Caution

The system should only be operated by trained personnel who are familiar with this manual and the operation of the instrument.

A condition for trouble-free and safe operation of this system is proper transport, proper storage, installation, assembly and proper use as well as careful operation and maintenance.



Warning

Any operation not described in the following instructions should be prohibited.

The system must be handled with the care required for an electronic precision instrument (protect from humidity, impacts, strong magnetic fields, static electricity and extreme temperatures). Do not insert any objects into the instrument.

The system is powered via the power cable with a voltage that can cause physical injury. Even after disconnecting the system from the power supply, dangerous voltages can temporarily occur due to capacitance.

Although the contacts of the integrated relays located at the back of the instrument are only approved for small electric currents, dangerous voltages or currents can occur in the case of faults or failures.

Extreme care must be taken with pressure connections when using hazardous or toxic media.

Repairs must only be performed by authorized service personnel.

Additional safety notices are found throughout this manual.

---

## 2.3 Warnings and Caution Notices



Warning

**HIGH PRESSURE!** High pressure gases are potentially hazardous. Energy stored in these gases can be released suddenly and with extreme force. High pressure systems should be assembled and operated only by personnel who have been trained in proper safety practices.



Warning

**POSSIBLE INJURY!** The tubing, valves and other apparatus attached to the controller must be adequate for the maximum pressure which will be applied, otherwise physical injury to the operator or bystander is possible.



Caution

**Caution:** use the proper pressure medium. Use only clean, dry non-corrosive gases. This instrument is not designed for oxygen use.



Warning

The user must use caution when controlling from a very high pressure down to a very low pressure when a vacuum pump is connected to the exhaust port. Large volumes of gas may be present in the device under test and will exhaust through the Vacuum/Exhaust port in excess of the capacity of the internal relief valve, possibly causing damage to the vacuum pump.



Warning

**HIGH SOUND LEVELS!** Pressures from 600 psig and up can generate sound levels above 100 db for brief periods when they are exhausted directly to atmosphere. If no muffling devices are attached to the exhaust/vent port, then ear protection is advised for personnel in the vicinity of the instruments that will be operated under such conditions.



Warning

**NOT EXPLOSION PROOF!** Installation of this instrument in an area requiring devices rated as intrinsically safe is not recommended.



Caution

**Caution: ESD protection required.** The proper use of grounded work surfaces and personal wrist straps are required when coming into contact with exposed circuits (printed circuit boards) to prevent static discharge damage to sensitive electronic components.



Warning

Before the system is switched on, the user must verify that the system was installed correctly and that all connections meet current regulations.

The user must ensure that all specifications such as supply voltage, operating temperature, humidity, sensor-specific pressure media and pressure ranges are observed.



Warning

Before pressurizing, the user must ensure through appropriate protective measures that the system or the device will not be overpressurized. When working with or on an instrument, safety glasses should be worn.



Warning

In areas where the system is operated there must be sufficient air ventilation due to inert gases that will escape during use.



Warning

High pressure can accelerate parts in a manner that could be hazardous and cause physical injury.

Additional warning and caution notes are included throughout this manual.

## 3 Product description

---

### 3.1 Proper Use

POC6 is a bench top or rack mounted Pressure Calibrator/Controller used for test and calibration of mechanical pressure gauges, sensors, transducers, transmitters and any pressure related devices where time to set point is a critical requirement.



Warning

**Only dry clean air or nitrogen should be used as the pressure medium. Shop air should be avoided and corrosive, oxidizing, condensing, explosive gasses should be strictly avoided.**

**The maximum permissible supply pressure at the supply port should be 10% over full scale value of the sensor installed.**



Warning

**Very fast pressure changes can damage the sensor, due to mechanical stress on the sensor; especially if the fast pressure change leads to an internal pressure which is higher than the full scale of the internal sensor (even if it is only for a fraction of a second). In some cases, the internal relief valves cannot react quickly enough to protect the sensor.**



Notice

The Internal pressure sensors have a calibration certificate (see enclosure: calibration certificate) for the entire measuring chain.



Warning

**The system is not suitable for use in areas with an explosion hazard.**

**If POC6 is not used according to this manual, safe operation of the system is not guaranteed.**

**The user of the system and not the manufacturer is responsible for all physical and material damage resulting from improper use!**

---

## 3.2 Features

1. POC6 will control (upscale or down-scale) into a 250 ml volume, to within 0.025% of the set point, in 3 seconds or less.
2. Uncertainty of 0.025% FS, one year calibration interval.
3. Lightweight compact case with optional handle.
4. Manual operation via the color touch screen and easy access to auxiliary screens allow quick changes to the set point using the "step" and "jog" screens.
5. Remote operation over RS232.
6. An optional internal high accuracy barometric reference sensor for emulation of gauge pressure and absolute pressure.
7. A large color SVGA LCD display with a touch screen for intuitive operator interface.
8. Multiple languages.



### 3.3 Turning on POC6

The power switch is located on the rear of the instrument as shown in Figure - "Rear Panel".

A: Power Switch



Figure - Rear Panel

### 3.4 Front Panel

POC6 front panel, shown in Figure - "Front Panel", includes a 7 inch color SVGA display featuring touch screen technology. Operator input is accomplished by pressing the number, words or symbols presented on the display. There are no mechanical keypads or switches on the front panel.

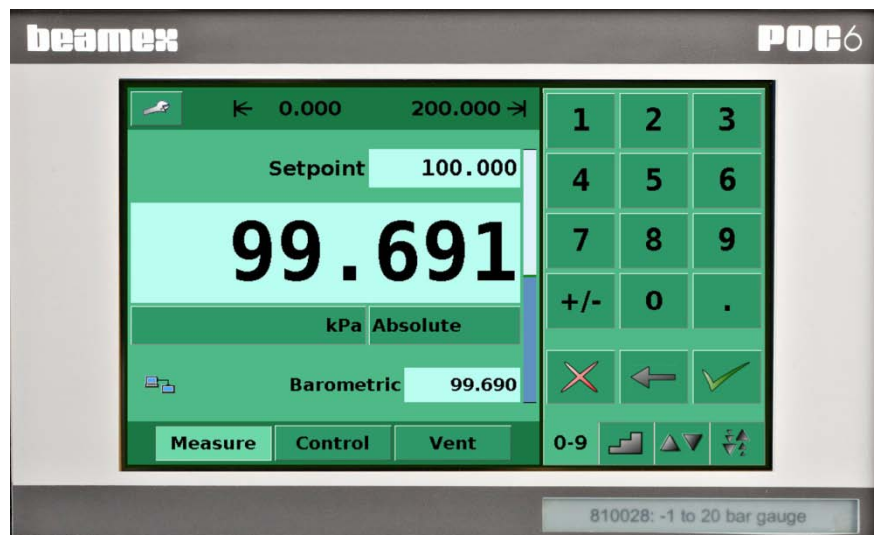

Figure - Front Panel

## 3.5 Main Menu

When POC6 is powered up it takes about one minute for initialization, then displays a screen similar to the Figure - "Initial Screen" below.

**A:** User defined control range limits. Configurable via SETUP-CONTROL.

**B:** SETUP key.

**C:** Stability indication.

**D:** Current pressure value.

**E:** Pressure units

**F:** Set point

**G:** Bar graph

**H:** Delete selected set point

**I:** Delete last entered digit

**J:** Accept selected set point

**K:** Numeric key pad

**L:** Operating Mode

**N:** Step key pad selection tab

**M:** Numeric key pad selection tab

**O:** Jog key pad selection tabs

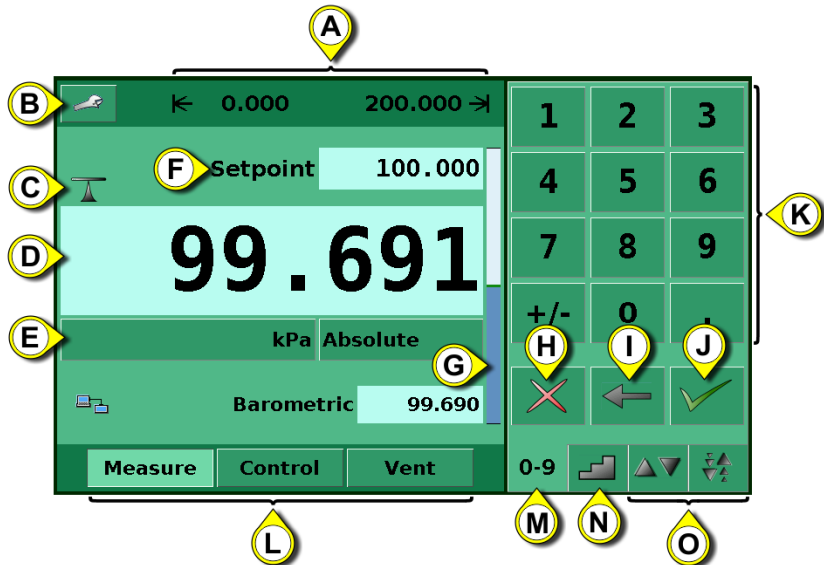





Figure - Initial Screen

### 3.5.1 Keys, Tabs, Check Boxes, Labels/Graphics

- Keys:** There are two types of keys: those that act as a switch to change a condition and those that open a data entry screen when pressed. Keys have borders with a three dimensional, shadowed effect (examples: **Measure** **Control** **Vent**, **0.004**). Throughout this manual keys are represented with the displayed characters enclosed in brackets (example: **[MEASURE]**) or a description and the actual graphic icon ( Example **[SETUP]** ). Pressing a key will have one of the following results: 1) instant, single step response, 2) continuously repeating steps while the key is held down, 3) the key will change colors indicating that the associated function is active or 4) a data entry dialog box will open. Operators will quickly become accustomed to the particular characteristics of the frequently used keys.
- Tabs:** Tabs are analogous to tabs in a notebook that allow switching quickly between related screens. Tabs are keys that allow the operator to switch between a group of screens that have a similar purpose, for example the **0-9**    tabs allow the operator to quickly switch between four screens used to enter the setpoint.
- Check Boxes:** Check Boxes  allow for the inclusion or exclusion of specific elements or conditions.
- Labels and Graphics:** Labels and Graphics are text, or graphic that display information, but do not respond to being touched (examples: **0.000** **200.000**). They indicate choices that have been made in the setup menus or indicate existing conditions as pressure is controlled or measured.

## 3.6 Front Panel Variations and Navigation

**Bar Graph:** The bar graph shows the relative indication of the range of the internal sensor, the user defined limits on the internal sensor, the unused portion of the internal pressure sensor range, the setpoint and the magnitude of the actual controlled pressure. The user defined control limits can be selected in the **Main->Setup->Control** screen and can be set to correspond to the range of the device under test. **It is important to note that when the STEP key pad is active in percent mode each step is a percent of the user defined limit not the full scale of the internal sensor.** This is useful when calibrating or testing various range devices. Figure "Bar Graph" shows the Bar Graph when the POC6 is in control mode controlling a pressure at the setpoint.

Bar graph shows relative indication of:

- Range of the Internal sensor
- User defined limits
- Unused portion of the internal sensor range
- Setpoint
- Current pressure reading



Figure - Bar Graph

### 3.6.1 Operating mode

(press **Measure** **Control** **Vent** to select mode):

- **MEASURE**  
In MEASURE mode, the instrument measures the pressure connected to the MEASURE port (on changing from CONTROL mode: the last controlled pressure will be held/sealed in the connected test assembly).
- **CONTROL**  
In CONTROL mode the instrument provides a very precise pressure at the MEASURE port.
- **VENT**  
VENT opens measure port to atmospheric pressure.

**Optional elements** can be chosen in the [SETUP-DISPLAY] screen explained in section 7.8.1 of this manual. Each optional element is displayed in the area below the pressure units.

- A: Area for optional elements
- B: Communication status
- C: Zeroing button, available in Vent Mode, if activated.
- D: Barometric reference display

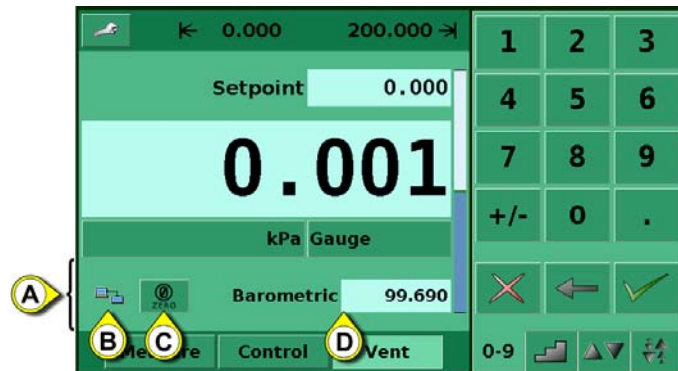

Figure - Optional Display elements

**Navigation to the SETUP** screens is achieved pressing the  icon. Setup Figure "Main Setup Screen" shows the setup screen with the display table activated. Other tabs at the bottom are used to navigate to additional setup screens. Setup screens will be discussed in detail in section 7.8 of this manual.



Figure - Main Setup Screen



### 3.7 Main Menu Setpoint Entry Options





Pressure setpoint entry options are chosen using the tab keys    .

Figure "Numeric Keypad" shows the main menu with the numeric keypad selected.

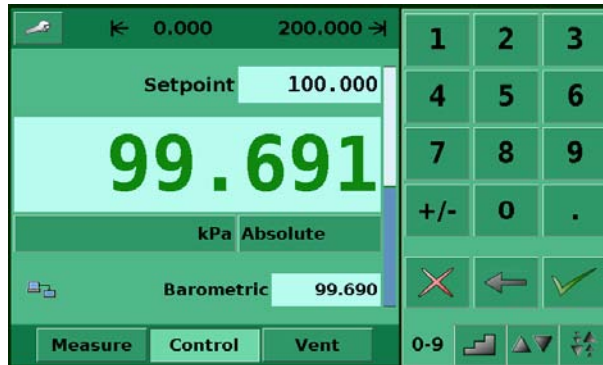

Figure - Numeric Keypad

Figure "Step Keypad" shows the main menu with the step keypad selected.

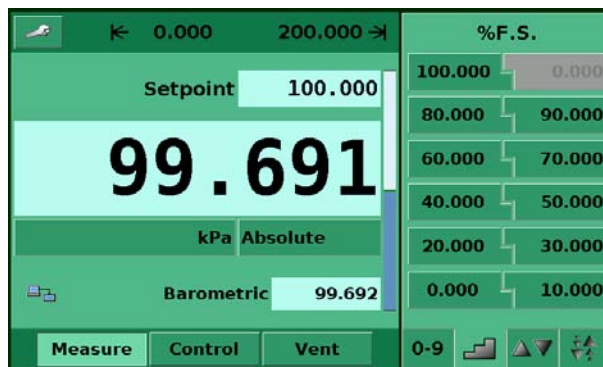

Figure - Step Keypad

Figure "Jog Keypads" shows the main menu with two jog keypads selected.

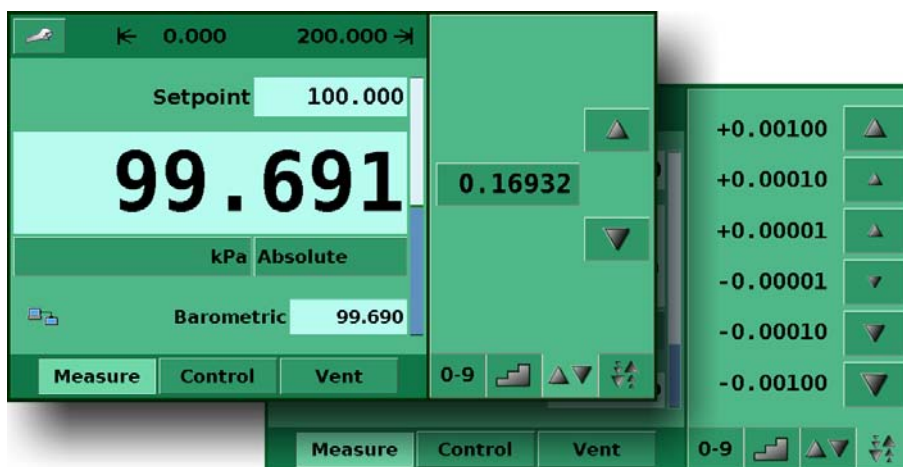

Figure - Jog Keypads

## 4 Specifications

Specifications	Unit	POC6
Pressure ranges	bar (psi)	± 1 bar (±14.5 psi) -1 to 6 bar (-14.5 to 87 psi) -1 to 20 bar (-14.5 to 290 psi) -1 to 70 bar (0 to 1015 psi) Special range within -0.95 to 70 bar (-14.5 to 1015 psi)
Minimum span	mbar (psi)	350 (5)
Pressure types		Absolute and gauge or bi-directional ranges
Precision	% FS	< 0.015
1 year uncertainty	% FS	< 0.025
Compensated temp range	°C	15 to 45
Calibration Interval	Year	1
Pressure units: English		psi, psf, osi, tsi, tsf, atm, inHg 0 °C, inHg 60 °F, mtorr, torr, inSW, ftSW, inH2O 4 °C, inH2O 20 °C, inH2O 60 °F, ftH2O 4 °C, ftH2O 20 °C, ftH2O 60 °F
Pressure units: Metric		mbar, bar, gm/cm2, kg/cm2, kg/m2, Dy/cm2, pascal, hPa, kPa, MPa, mmHg 0 °C, cmHg 0 °C, mHg 0 °C, mSW, mmH2O 4 °C, cmH2O 4 °C, mH2O 4 °C, mmH2O 20 °C, cmH2O 20 °C, mH2O 20 °C
Pressure units user defined		2 (multiplier from psi or Pascal)
Control stability	% FS	< 0.004 (of the internal sensor range)
Slew rate	sec.	< 3 (up or downscale into a 250 ml test volume to within 0.025%FS of the setpoint for pressures above 700 mbar.)
Control range		From 0 up to 100 % FS
Minimum control pressure		0.05% FS or 0.025 psi over exhaust pressure, whichever is greater.
Overshoot	%FS	<1
Pressure ports		7/16"- 20 F SAE. includes adapters to ¼ inch and 6 mm tube fitting
Filter elements		20 micron filter element included in each pressure port (excluding the optional barometer and the reference port on a Gauge sensor)
Permissible pressure media		clean dry non-corrosive gases
Parts exposed to pressure media		Aluminum, brass, 316 and 316L stainless steel, Buna N, Viton, glass filled epoxy, RTV, Nylon
Overpressure protection		Pressure relief valves
Pressure supply consumption	l/min	<2.5 scfh in steady-state control.
Instrument mounting		Desk top with bezel and handle, or optional rack mount kit.
Screen		7.0" color LCD with 4 wire resistive touch-screen
Resolution	digits	4 up to 6
Measuring rate	readings	25/sec
Warm-up time	min	approx. 15
Shock/Vibration	g	maximum 2 per MIL-T-28800
Digital Interface		RS232, Ethernet, IEEE-488, USB (optional)
Power Supply		90 - 250 VAC, 50/60 Hz, 90 VA max
Maximum pressure - supply port	% FS	105 ... 110
Pneumatic overpressure protection		relief valves are installed; set 10-25% over the maximum sensor pressure
Operating temperature	°C	0 ... 50
Storage temperature	°C	0 ... 70
Air humidity	%	0 ... 95 (relative humidity without moisture condensation)
Operating position		Negligible, can be removed with re-zeroing
Weight	kg (lbs.)	<9.1 (<20) with all internal options
Dimensions	mm (in.)	133 x 213 x 305 (5¼ x 8½ x 12) (see section 5.3)
CE-mark		Conformity certificate
Calibration		Accredited Calibration Certificate included

# 5 Installation

---

## 5.1 Introduction

The initial installation of POC6 includes the following steps: Unpack the system, place it in a suitable workspace, connect it, switch it on and configure.

---

## 5.2 Unpacking and Inspection

At the factory each new POC6 passes a careful inspection. It should be free of scrapes and scratches and in proper operation order upon receipt. The receiver should, however, inspect the unit for any damage that may have occurred during transit. If there are signs of obvious mechanical damage, package contents are incomplete, or the instrument does not operate according to specifications, contact the purchasing sales office as soon as possible. The standard accessories are as follows:

- Calibration certificate
- this User Guide
- Mains cable
- Vacuum connection hose and connectors
- Supply pressure connection hose and connectors
- Low pressure models (20bar/300psi and lower) a pressure T-hose set
- High pressure models (over 20bar/300psi) a high pressure connection hose

If you have to return the instrument to the factory for any reason, use the original packing whenever possible. Include a detailed description of the reason for the return.

---

## 5.3 Dimensions in mm

The instrument can be set up on a table top or it can be rack-mounted. Rack mount adapters are optional on POC6 and require an adapter panel.



Figure - Dimensions in mm

---

## 5.4 Installation

### The installation site must meet the following conditions:

- Operating Temperature: 10 to 50 °C
- Humidity: 35 to 85 % relative humidity non-condensation
- Flat, horizontal location; secure fixed working surface (desk top model) or installation in a rack mount.
- At the back of the instrument sufficient air circulation must be provided for to avoid an accumulation of the heat conducted to the outside via the fan.
- During operation, pressure escapes through the vent port in the back of the instrument. Personnel should not have access to the rear vent and exhaust port during operation.

### Avoid the following influences:

- Direct sunlight or proximity to hot objects
- Unstable installation position
- Mechanical vibration
- Proximity to sources of strong electromagnetic fields, such as high tension appliances, mobile telephones or mains
- Soot, steam, dust and corrosive gases
- Environment with explosion hazard, inflammable atmospheres

### Pressure supply requirements:

- Stable supply pressure 10% higher than the full scale of the internal transducer
- Permissible media: dry, clean air or nitrogen
- Vacuum: min. 50 litres/min (if required)



Notice

An angle of inclination of the system of more than 3 degrees can cause a deviation in the measured pressure and should be avoided. Zeroing the unit at the angle of inclination will nullify this deviation.



Warning

**Applying supply pressure higher than the recommended pressure can cause permanent damage to the controller!**

## 5.5 Rear Panel

Four pneumatic pressure ports are located on the rear panel (see below: Figure - "Rear panel"). Positioned on the left are the Ethernet and RS-232 and GPIB connector, the off/on switch, the line fuses, and a protective grill covering the ventilating fan.



Figure - Rear panel

## 5.6 Pressure Connections



Warning

The pressure connections must be installed according to the following instructions, observing the relevant regulations. The installation should be performed by persons familiar with, and who can work according to, the safety regulations for working on pneumatic/hydraulic systems.



Notice

When making up a connection to an o-ring adapter port use a back-up wrench to prevent over-stressing the threads in the manifold block.

All of the pressure ports on the rear are female 7/16 - 20 SAE/MS straight threads per MS16142 and SAE J514 table 14. They require a tube fitting boss seal with an o-ring per MS33656. Beamex provides female 1/4 inch and 6 mm tube fittings with the instrument. The pressure connections can be made to these adapters with the proper mating hardware. Do not use sealant on fittings sealed with an o-ring.

## 5.7 Function of Pressure Connections

- **MEASURE/CONTROL port**

Below the label "MEASURE/CONTROL" is a pressure connection. In MEASURE mode this connection connects the pressure applied to the internal sensor where the pressure is measured (within the range of the internal sensor). In CONTROL mode this connection supplies an output pressure controlled by the internal regulator at the commanded setpoint.

- **SUPPLY port**

Below the label "SUPPLY" is a pressure connection. This connection should be supplied with a pressure that is approximately equal to 110% of the full scale pressure of the internal sensor. In other words, 10% above the full scale pressure of the internal sensor (see "Supply Pressure" in the specifications section for supply pressure and pressure media requirements.)

- **EXHAUST/VACUUM port**

Below the label "EXHAUST/VACUUM" is a pressure connection. If a sub-atmospheric control pressure is required a vacuum pump must be connected to this port. Otherwise, this port may be left open to atmosphere.



Warning

**The user must use caution when controlling from a very high pressure down to a very low pressure when a vacuum pump is connected to the exhaust port. Large volumes of gas may be present in the device under test and will exhaust through the Vacuum/Exhaust port in excess of the capacity of the internal relief valve, possibly causing damage to the vacuum pump.**

- **VENT outlet**

Below the Label "VENT" is the pressure outlet. In VENT mode the pressure within the system is released through this outlet.



Warning

**HIGH SOUND LEVELS! Pressures from 600 psig and up can generate sound levels above 100 db for brief periods when they are exhausted directly to atmosphere. If no muffling devices are attached to the exhaust/vent port, then ear protection is advised for personnel in the vicinity of the instruments that will be operated under such conditions.**

- **REFERENCE port**

On gauge units this port is connected to the reference side of the transducer, and on absolute units it is internally capped. This port is normally left open to atmosphere but may be attached to a snubber assembly on very low pressure instruments.



Warning

**The controller must be protected from over pressure.**

**Pipes, couplings and other components used for connecting the supply exhaust and the Measure/Control port must be suitable for the application and rated for the applied pressures.**

**The user must ensure that the pressure media are clean and dry. If necessary, the internal sensors and mechanisms must be protected by using a liquid trap or coalescing filter.**

---

## 5.8 Electrical Connections



The electrical installation has to be performed according to the following instructions while observing the relevant regulations. It is to be carried out by a qualified electrician.

### 5.8.1 Connecting the Power Supply and Turning On the Instrument



Before connecting the power supply, make sure that the supply voltage agrees with the specification of the power unit. Switch off the system before connecting the power via the power switch at the rear of the instrument.

Only the power cable supplied should be used.

The 3-pin power cable supplied is fitted with a ground lead. Operate the system only from a 3-pin socket and always make sure that the ground lead is properly connected.

The power input socket is to be connected according to the regulations with the country-specific connection cable supplied to a power supply that lies within the required specification. To power-on the instrument switch the power switch ON (located on the rear of the instrument; also see chapter 6 "Starting operation").

### 5.8.2 Connecting the Communications Interfaces

#### RS-232

There is a RS-232 connection on the rear panel of POC6.

#### USB 2.0 FS Interface (optional)

The USB 2.0 FS connection on the rear panel of POC6 is a USB-B Type connector.

#### IEEE-488 Interface (GPIB)

The connection of the IEEE-488 interface is designed as a 24-pin IEEE-488-socket.

#### ETHERNET Interface

The Ethernet communication port allows POC6 to communicate with computers using 10/100 Based-T specifications.



**Please consult your Computer Resources Department prior to connecting this instrument to your network to verify there are no conflicts with existing IP addresses.**

Ethernet communications are transmitted over a standard RJ-45 cable. Prior to first time use of Ethernet communication, the four parameters, IP, Netmask, Gateway, and Port must be setup. These are configured in the communications setup screen.

## 6 Starting Operation



Warning

**Before the system is switched on, verify that the system was installed according to the instructions of the previous section and that all connections installed are fitted according to the current regulations.**

**Operators must ensure that all specifications that apply to supply voltage, operating temperature, humidity, pressure media and pressure ranges are observed.**

**Condensation can occur inside the system when the temperature changes abruptly. Give the system sufficient time for acclimation in such cases.**

**Before pressurizing, the operator must ensure that the system and the device under test will not be over pressurized. When working with or on the instrument, safety glasses should be worn.**

**In the rooms in which the POC6 is operated sufficient air ventilation has to be ensured.**

When the above points have been met you can switch on the system, (the switch is located on the rear of the instrument) and configure it as required after you have familiarized yourself with the operation (see section: "Operation (via Touch-screen)"). After turning the power switch to ON, the instrument will go through a brief initialization process and system check, which will take about 40 seconds. As soon as the system check is completed the system will default to an operating screen similar to "Figure-Initial screen" in section 3.6. Allow at least 15 minutes of warm up time to achieve thermal equilibrium between the controller and its environment before performing critical pressure measurements.





# 7 Local Operation

This section describes the procedures for operating POC6 from the front panel.

- **Tabs, Keys, Value Entry and Check Boxes:**  
Local operation is accomplished by observing the data presented in the display menus, then pressing the on-screen **tab**, **key**, **value entry** or **check box** for the desired sub-menu, function or selection. Tabs are used to access the subset of a menu, keys open new menus, make selections or change a parameter, value entry opens a keypad to enter a value, and check boxes allow choice of associated display option.
- **Screen Hierarchy:**  
Navigation within the POC6 is similar to a computer file system or a web page. Keys or tabs activate sub-menus. Within the sub-menus there may be related sub-menus or selections. To return back through the hierarchy of screens the **[BACK]**  key is provided. Throughout this manual screen hierarchy will be designated using the following convention: "**main->sub-menu->selection**" or "**main->sub-menu->tab->selection**". The Hierarchical menu structure is very intuitive and will become more obvious after reviewing following examples.

---

## 7.1 Setting the Operating Language

In the upper left corner of the main display is the **[SETUP]** key . To change the language select the **[SETUP]** key and select the **[DISPLAY]** tab if not already active. In the box labelled "view" on the upper right side of the resulting **main->setup->display** screen there is a **[FLAG]**  key. Press the **[FLAG]** key and a selection of language keys will appear. Select the desired language. Then press the **[BACK]** key to return to the main menu which will now display in the selected language. Using our convention, selecting English would be described by the following: **main->setup->display->flag->english**

---

## 7.2 Display Configuration

POC6 main menu Figure - "Main Menu" shows the main screen that appears when the unit is turned on. A point by point description of each element is shown in this figure. The **setup** key  opens the setup menu where changes can be made and information viewed. Each sub-menu in the setup menu can be activated by pressing the **[DISPLAY]**, **[CONTROL]**, **[REMOTE]**, **[INFO]** or **[SERVICE]** tab. Each of these setup sub-menus will be discussed in detail in chapter 7.8.

The points on the main menu that are independent of the setup menus are the setpoint indication, the actual pressure reading, the units of measure and the control modes (measure, control and vent), plus the four tab menus  used for selecting a setpoint. The **[PRESSURE UNIT]** key indicates the currently chosen pressure unit and can be pressed to open a menu that allows selection of English, metric, or user defined pressure units.

POC6 main menu shown in "Figure - Optional Elements" shows elements that can be displayed on the main menu and describes the three choices available for setpoint entry (Numeric Keypad, Step and Jog). Optional elements include the Communication status icon which indicates a connection or disconnection from a remote computer, and the barometric reference indication

showing the value of the atmospheric pressure measured by the optional internal barometric reference sensor.

**A:** User defined DUT / control range limits. Configurable via SETUP.

**B:** SETUP key

**C:** Stability indication

**D:** Current pressure value

**E:** Pressure units

**F:** Set point

**G:** Pressure mode indication

**H:** Bar graph

**J:** Delete last entered digit

**K:** Accept selected set point

**L:** Numeric key pad

**P: MEASURE**

Measure mode pneumatically connects the pressure sensor directly to the device under test. In measure mode pressure regulation is inactive.

**Q: CONTROL**

In the control mode, the device regulates the pressure output according to the set point value, providing a precise pressure at the test or measure port.

**R: VENT**

Vents the system and the device under test to atmospheric pressure.

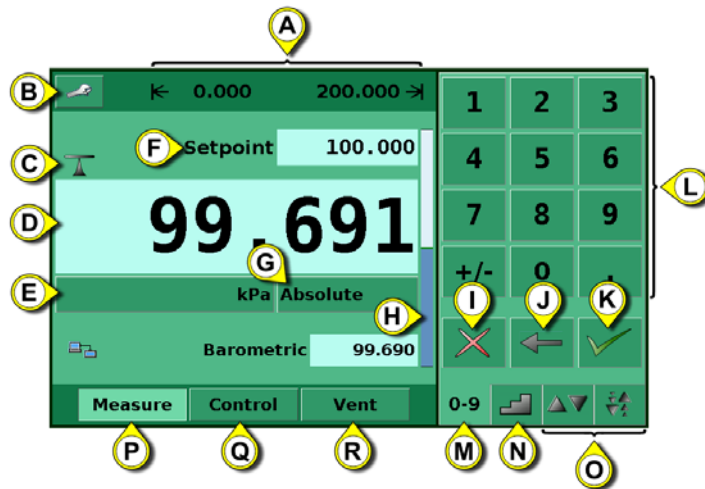

Figure - Main Menu

**A:** SETUP key For opening the SETUP menu

**B:** Pressure emulation mode

**C:** Communication status

**D:** Zeroing, available in Vent Mode, if activated.

**E:** Optional barometric reference display

**F:** Numeric key pad selection tab

**G:** Step key pad selection tab

**H:** Jog key pad selection tabs

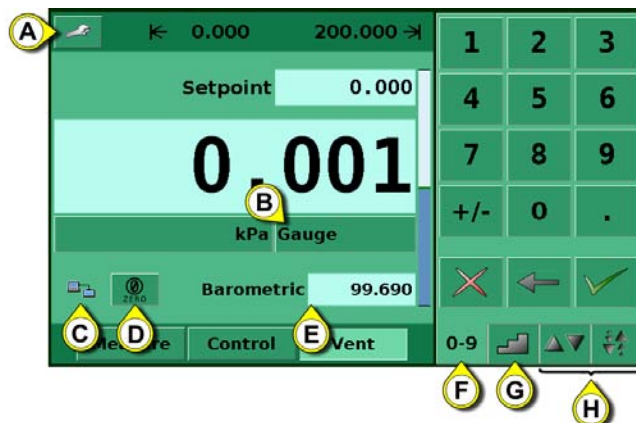









Figure - Optional Elements

Note.

See the following page for detailed information on each set point entry screen.

## 7.3 Setpoint Entry

The control setpoint can be entered using the default Numeric Keypad or the alternate Step or Jog keypads that appear on the right side of the main menu when selected using the **[SETPOINT ENTRY SIDE-MENU]** tabs     on the lower right hand side of the main menu. These alternative methods of entering the setpoint have advantages in different situations and have been designed to increase ease of use and productivity.

The Numeric Keypad shown in figure - "Numeric Keypad", is the default keypad that appears every time the unit is turned on or can be activated using the [0-9] tab. A setpoint value can be entered directly using this keypad. As the value of the setpoint is entered the setpoint field will turn blue and the entered value will appear in the field. The Setpoint value can be deleted completely using the **[DELETE]**  key, the last digit of the entered setpoint can be deleted using the **[CLEAR ENTRY]**  key or the setpoint value can be accepted using the **[ACCEPT ENTRY]**  key. When the **[ACCEPT ENTRY]** key is pressed, the setpoint field will turn white and the new setpoint will become active. In control mode, the controller output will ramp to the entered setpoint. **Caution:** If the **[ACCEPT ENTRY]** key is not pressed the previously entered setpoint will remain active.

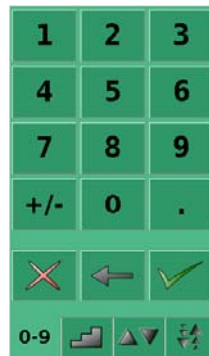

Figure - Numeric Keypad

The Step keypads shown in figure - "Step Key pads", provide a way to increment the setpoint by defined steps. Steps are a percent of the user defined limits set in the **main->setup->control** or actual pressure values that are displayed in the pressure units selected in the main menu. A total of 12 steps are provided. When a step is pressed the related setpoint is immediately entered as the active setpoint. In control mode, the controller output will ramp to this setpoint. The Step Keypad can be modified in the **main->setup->display** menu discussed in section 7.8.1.



Figure - Step Keypads

The Jog Keypads shown in figure - "Jog Keypads", provide a way to jog the setpoint up or down by custom steps and fixed small increments (left and right picture respectively).

The custom step may be manually set to suit your own needs. The fixed increments are determined by the resolution, the maximum control limit and/or the units of measure. For example, if the resolution is set to display five decimals then the small triangle pointing up will change the setpoint by 0.00001 and the small triangle pointing down will change the setpoint by -0.00001. In the same way, the medium triangles will change the setpoint by +/- 0.00010 and the large triangles will change the setpoint by +/- 0.00100 as shown in the figure. When the Resolution, the maximum control limit or the units of measure are changed so that, e.g. four decimals are displayed, then the jog functions will change to +/- 0.0001, +/- 0.0010 and +/- 0.0100 respectively. This is useful when adjusting the controller to reach a cardinal point on a dial gauge.

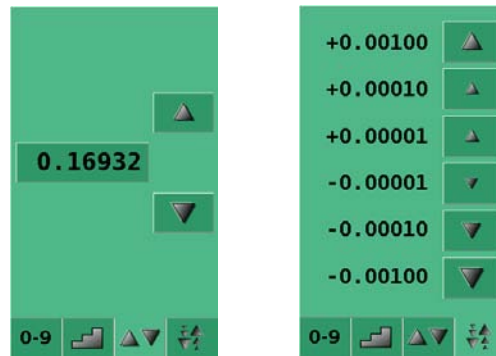

Figure - Jog Keypads

## 7.4 Operating Modes

The selection keys for the operating modes Measure, Control and Vent are located at the bottom of the main menu.

- **[MEASURE]**  
In measure mode, the instrument measures the pressure connected to the **MEASURE/CONTROL** port. Figure -"Measure Mode" shows the state of the isolation valves in measure mode.



**When POC6 is turned off all the valves close and could trap pressurized gas within the pneumatics. It is safe practice to vent after use and before connecting any devices to the Measure/Control port.**

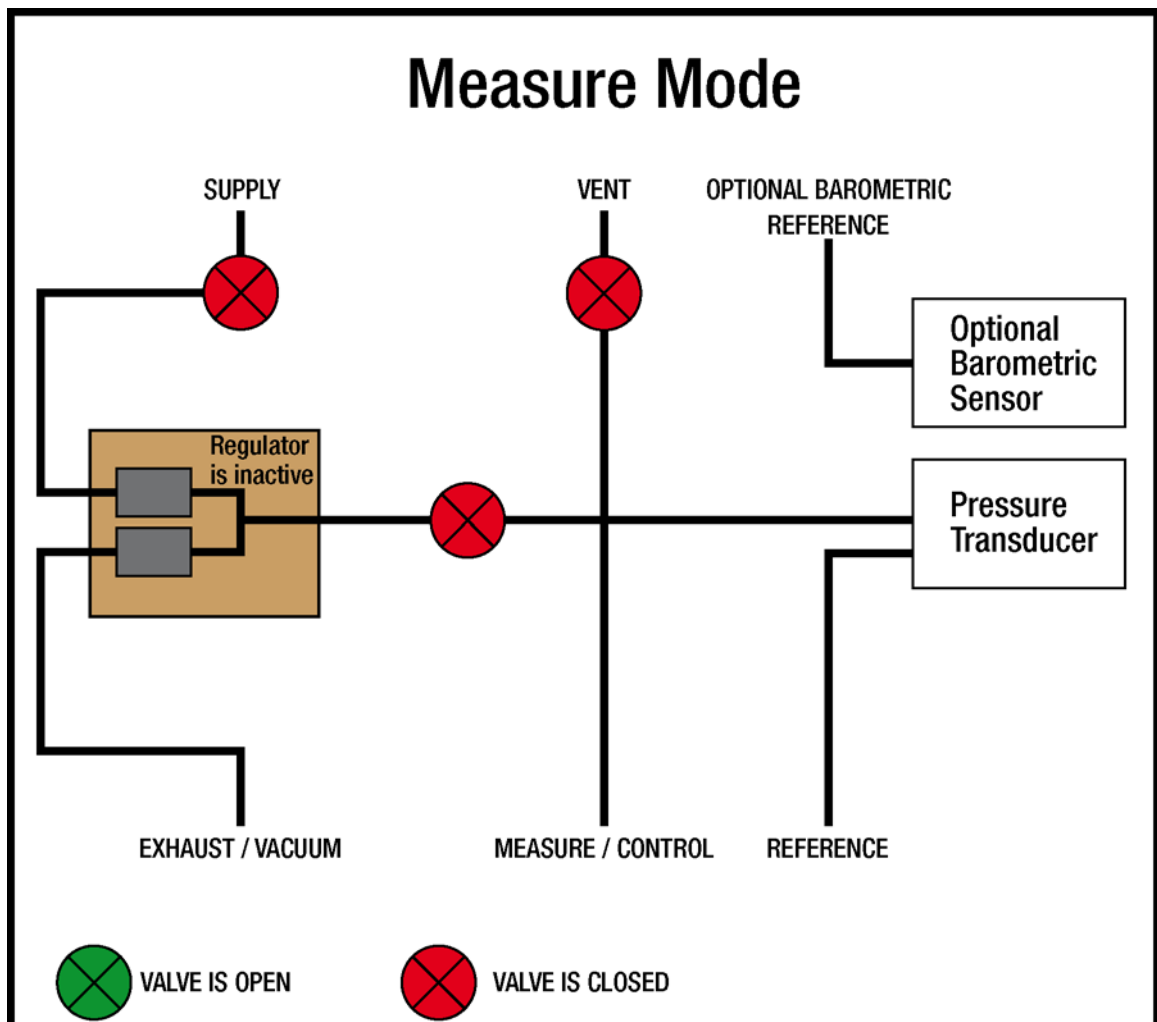
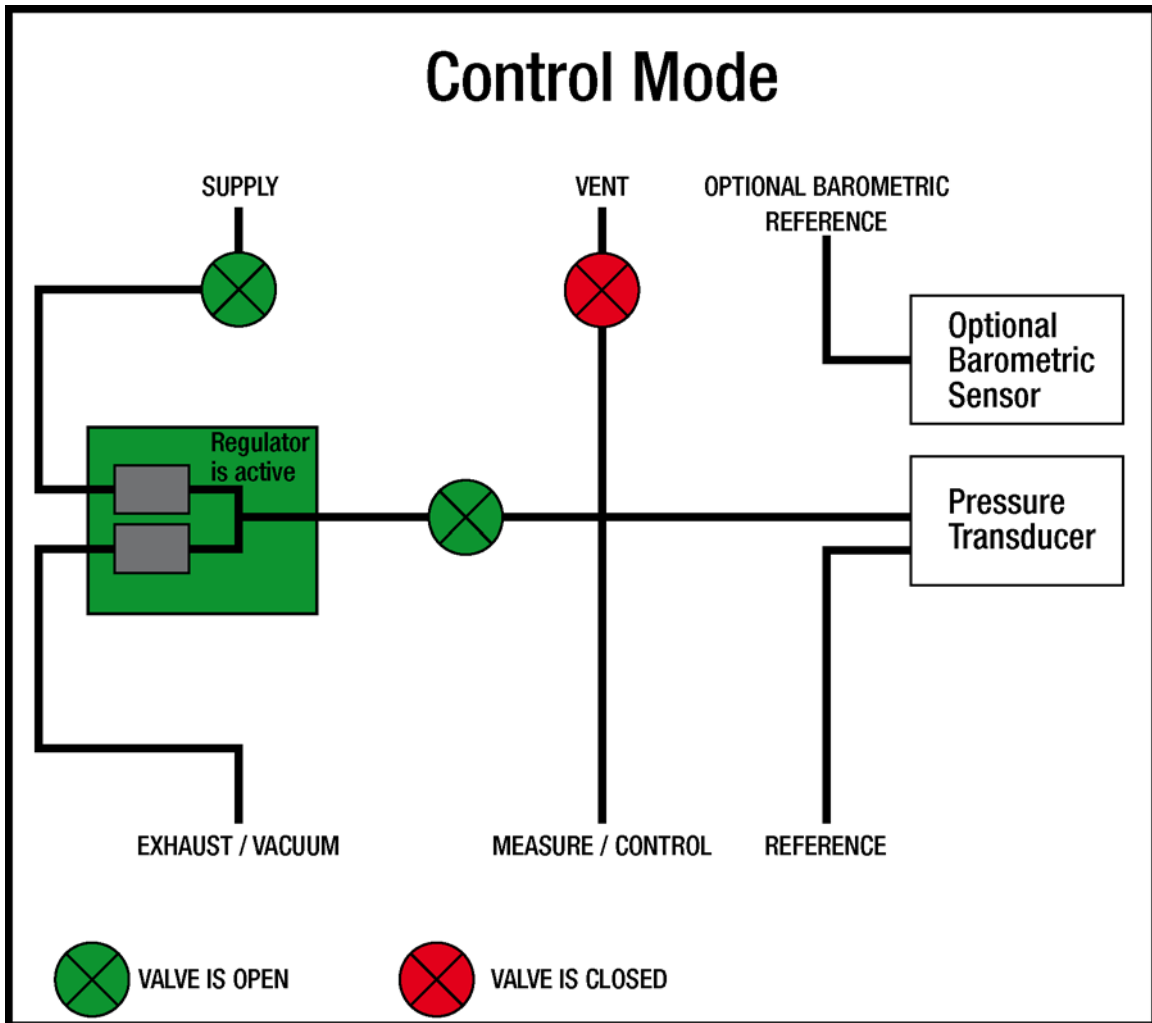

Figure - Measure Mode

- **[CONTROL]**

In control mode the instrument provides a precise pressure output (equal to the SETPOINT +/- the stability specification) at the Measure/Control port. The indication of the current pressure value will turn green when the setpoint has been reached and the stable window settings have been satisfied. Figure -"Control Mode" shows the state of the isolation valves in measure mode. Notice that the regulator is active in the control mode.



*Figure - Control Mode*

- **[VENT]**  
Vent mode vents the pneumatic system and shuts off the supply. Figure -"vent mode" shows the state of the isolation valves in vent mode.

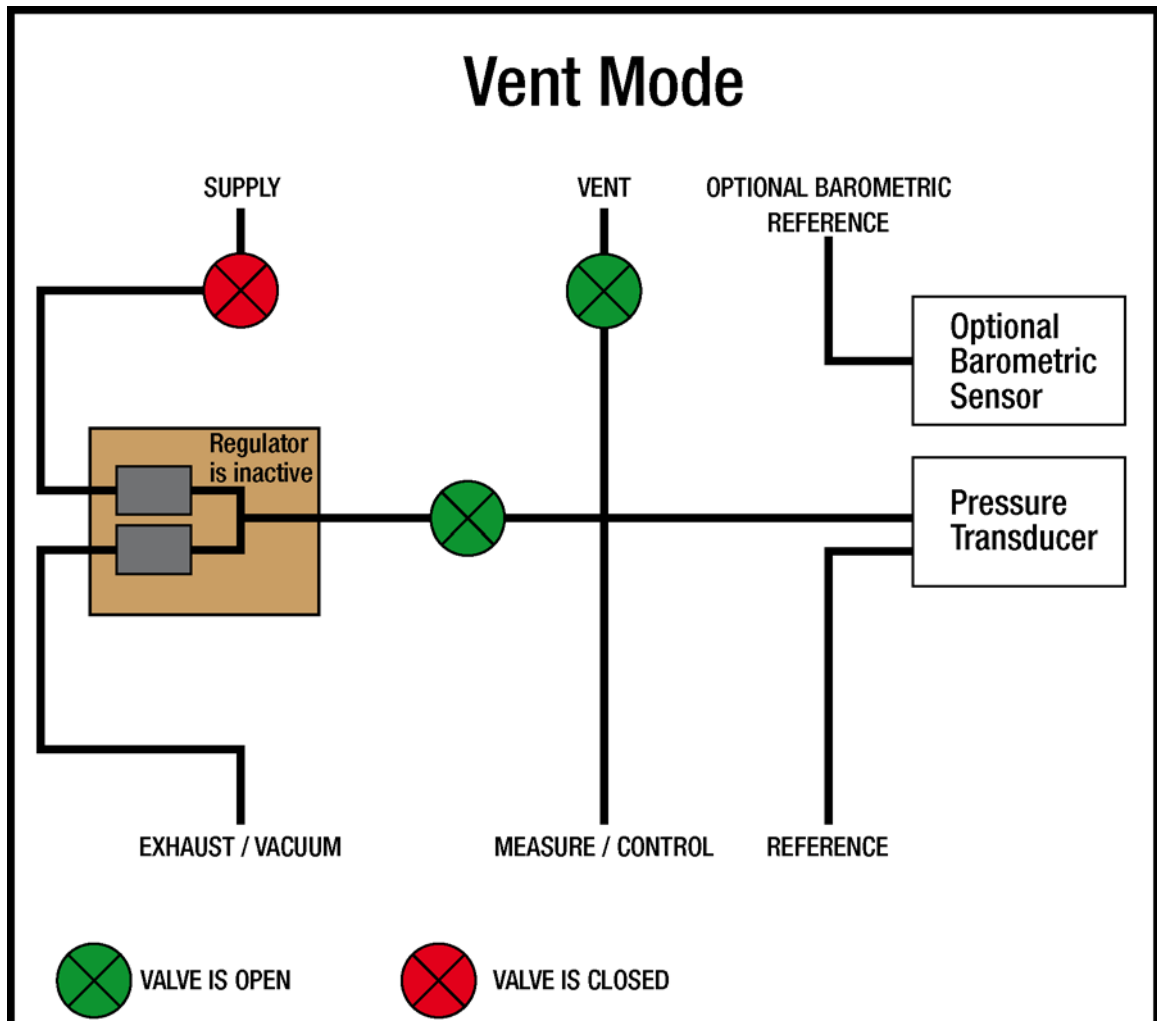





Figure - Vent Mode

## 7.5 Data Entry

When there is a requirement to enter specific numeric or alpha values into the system, the method of entry is consistent for all instances. When a **[VALUE ENTRY]** key is pressed a dialog box will appear similar to Figure - "Value Entry". This Value Entry Dialog box will have a numeric or alpha keypad, when appropriate minimum and maximum value limits, current value and a window that shows the new value entered. The value can be deleted completely using the **[DELETE]**  key, the last digit of the entered setpoint can be deleted using the **[CLEAR ENTRY]**  key or the setpoint value can be accepted using the **[ACCEPT ENTRY]**  key.

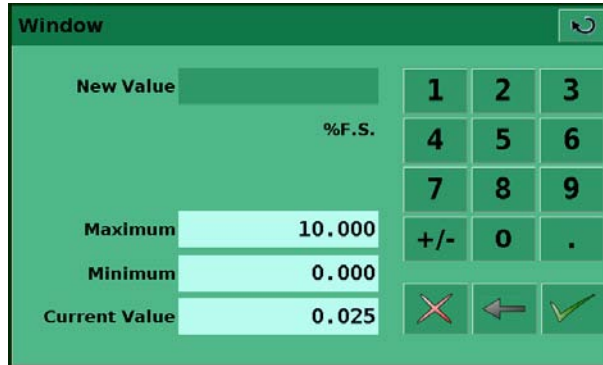

Figure - Value Entry

## 7.6 "Pressure Unit", "Pressure Mode" and "Emulation Mode"

The Pressure **[UNIT]** key is shown on the main screen below the current pressure value and displays the most recently chosen pressure units and the mode (absolute or gauge). If the optional barometric reference is installed a **[MODE]** key replaces the mode indication to the right of the units key. This **[MODE]** key indicates absolute or gauge mode. When the key is pressed it will switch between the "native mode" of the internal sensor to the emulation mode. The "native mode" is the mode of the sensor that is installed and is either absolute or gauge. Emulation mode uses the value of the barometric reference to emulate the mode that is alternate to the native mode. POC6 can emulate gauge from a native absolute sensor or absolute from a native gauge sensor. The **[MODE]** key indicates the native mode with a blue key background and emulation mode with a light blue key background. The units and mode chosen remain the same when POC6 is turned off then back on.

Native sensor is gauge, no barometric reference installed.



Native sensor is gauge, barometric reference installed.



Native sensor is gauge, barometric reference installed and absolute emulation active.



Pressing the **[UNITS]** Key will open a dialog box that shows the available pressure units with a tabs for **[ENGLISH]**, **[METRIC]** and **[USER UNITS]** units. Pressing a tab will open a menu with the related set of units available. The **[USER UNITS]** tab menu includes **[USER 1]** and **[USER 2]** keys and allows the user to enter customized pressure units. Press the **[MULTIPLIER VALUE]** key to enter a multiplier that defines the user unit as the multiplier times one psi or one Pascal, whichever is currently pressed.



A gray background on a **[PRESSURE UNITS]** key indicates that it is the current selection. Touch any other **[PRESSURE UNITS]** key, and press **[BACK]** key to enable change and return to previous operation screen. All of the displayed pressure values will have changed to correspond to the newly selected units.

## 7.7 Bar Chart

The Bar chart shows the relative indication of the current pressure value with respect to the full scale value of the internal sensor and the user defined minimum and maximum limits (see section 7.8.7 for setup of user defined limits). The full height of the bar graph is proportional to the internal sensor range. The green line indicates the magnitude of the setpoint. The blue column indicates the magnitude of the current pressure. The cross hatched section indicates the portion of the internal sensor above or below the user defined limits that is not being used.

- A: Initial sensor range
- B: Portion of internal sensor range outside of the user defined limits
- C: User defined limits
- D: Current pressure
- E: Set point (green line)

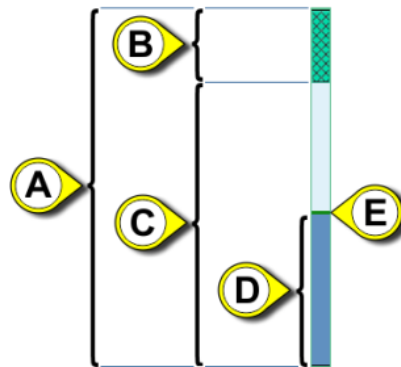

Figure - Bar Chart

## 7.8 Setup Menus

The setup menus are opened by pressing the **[SETUP]**  key. This opens the menu shown in Figure - "Setup". The setup menu has five tabs: **[DISPLAY]**, **[CONTROL]**, **[REMOTE]**, **[INFO]** and **[SERVICE]**. Each tab is described in detail in the following sections. The screen below has the **[DISPLAY]** tab active.



Figure - Setup

## 7.8.1 Setup Display

The **main->setup->display** menu contains elements that change the appearance and function of components displayed on the main menu. Following is a description of the elements of this menu.

- **Filter:** The filter selection keys **[LOW]**, **[NORMAL]**, and **[HIGH]** dampen the pressure display to reduce the affect of pneumatic noise associated with the device under test or the test environment.
- **Resolution:** The resolution section of the Setup Display menus allows the user to change the resolution of the current pressure reading to be **[4]**, **[5]** or **[6]** digits.
- **Stable Window and Delay:** The stable window is the percentage of the full scale value of the internal sensor that the current pressure can deviate +/- from the setpoint and still display a stable indication. The stable delay is the number of seconds that the instrument must remain within the stable window before the stable indication is displayed.
- **Language:** The "view" Section of the setup display menu shows a flag, a country and a language on a key. This is the current language. Press this key to access a menu containing other languages that are available. Figure "languages" below shows the language selection screen.



Figure - Languages

- **Display Brightness:** Move the vertical bar to change the display brightness
- **Audible Feedback [Check Box]:** Check this item if you want to have audible feedback when "pushing" the buttons on the touch screen.
- **Barometer (optional) [Check Box]:** This enables or disables the indication of the barometric pressure on the main menu.
- **Remote Status [Check Box]:** The Remote status check box enables or disables the remote status icon on the main menu. This icon will show a broken wire when there is no connection to a remote computer or a connected wire if the computer is connected.
- **Zeroing [Check Box]:** When checked, this allows you to zero the pressure sensor during **Vent Mode** in the main menu. Note that this selection is password protected. More of passwords in chapter 7.8.5 **Setup Service** on page 31.

## 7.8.2 Setup Control

Configuration of parameters associated with setting limits and adjusting parameters used to control pressure are configured in the **Main->Setup->Control** menu shown in Figure - "Setup Control".

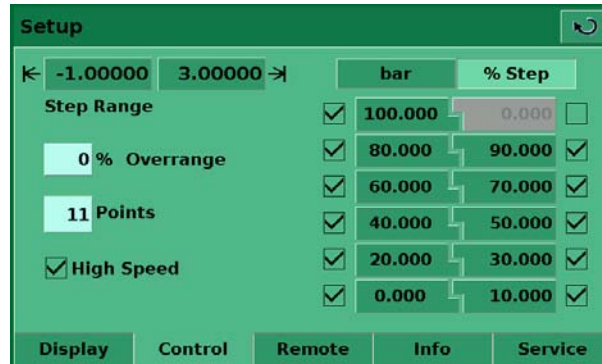

Figure - Setup Control

- Maximum and Minimum Control Limits:** The [DATA ENTRY] keys next to the [MINIMUM] and [MAXIMUM] labels in Figure - "Setup Control" allow the operator to select any range within the full scale range of the internal sensor. This is the "user defined range". For example: if POC6 has a 0-5 psi internal sensor, the user can define a range of 0-4 psi. When the user defined range is changed, a corresponding change occurs in the step menu so that the percent step will equal the corresponding value within the user defined range. For example: the 80% value of a 0-4 psi user defined range will be 3.2 psi but for a user defined range of 0-2 the 80% value equals 1.6 psi. **The user defined range can be set to the same range as the pressure device being tested. This useful when there is a test that requires calibration at intervals equal to a percentage of the range.** Each individual step can also be changed by pressing the [step] 80.000 key and entering a new value.
- PSI or % Step:** The [SELECTED UNITS] and [% Step] PSI % Step keys switch the step keypad display in the main menu and on the setup screen from the user selected units to percent of the full scale of the user defined range. The values when shown in the [SELECTED UNITS] mode correspond to the values in the [% Step] mode. For example, in Figure - "PSI Mode", the [PSI] key is pressed and the value shown in the 100% step is 3.0000 corresponding to the maximum limit chosen in this same screen. Individual steps in % Step or Selected Units mode can be included or excluded from the step menu by changing the [Check Box] next to the step.

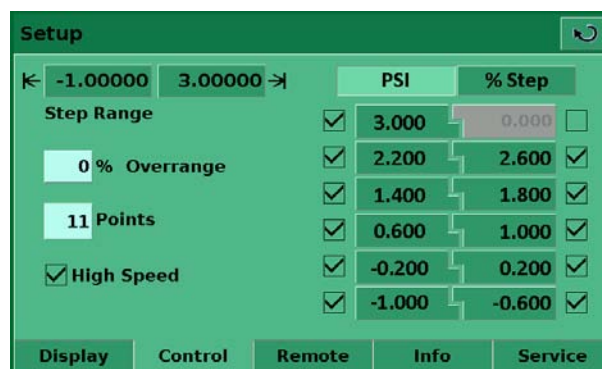

Figure - PSI Mode

- **[Points]** allows the operator to select the number of points that appear as steps. For example: in Figure - "Points" [5] is entered as the "Points" value. This automatically configures 5 points from 0 to 100% of user defined range. It automatically calculates the steps that populate the step keypad in the main menu.

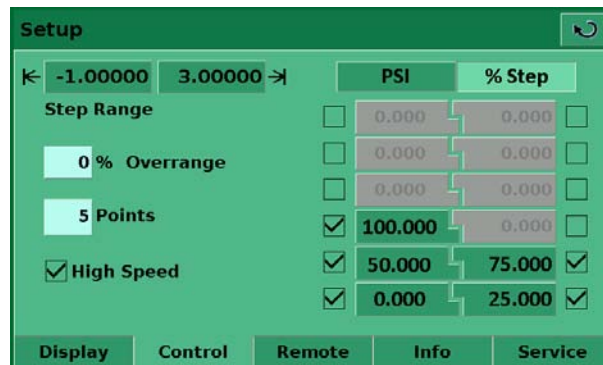

Figure - Points

### 7.8.3 Setup Remote

Configuration of parameters associated with remote communication are set up in the **Main->Setup->Remote** screen.

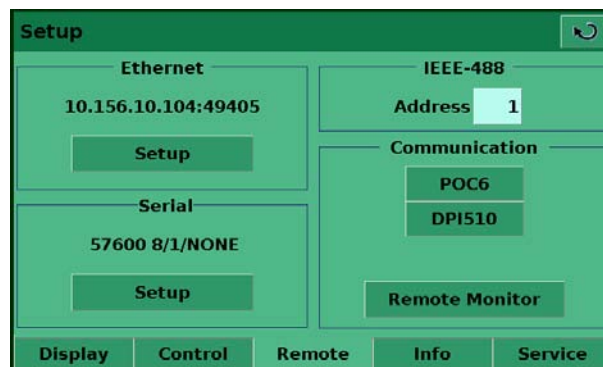

Figure - Setup Remote

- The Ethernet setup key opens a dialog box where host name, IP, netmask, gateway, port, and client IP can be entered. There is also a check box that will activate (checked) or deactivate (unchecked) Dynamic Host Configuration Protocol (DHCP). DHCP is a protocol used by networked devices (clients) to obtain the parameters necessary for operation in an Internet Protocol network. This protocol reduces system administration workload, allowing devices to be added to the network with little or no manual configuration.
- The USB setup key opens a dialog box where baud rate (9600, 19200, 38400, 57600, or 115200), data bit (7 or 6), stop bit (1 or 2), parity (none, odd or even) can be chosen. There is also a check box that turns echo on (checked) or off (unchecked).
- The IEEE address data entry button when pressed will open a data entry dialog box where the IEEE address can be entered.
- In the Communication section there are two remote command set emulation settings. The **[POC6]** key enables the standard Beamex command set, and the **[DPI510]** key enables the command set that will communicate with the Druck DPI 500 series of controllers. In this section there is also a **[REMOTE MONITOR]** key that will open a screen that shows the most recent commands and responses sent and received plus any errors.

## 7.8.4 Setup Info

The **Main->Setup->Info** screen, Figure - "setup info", provides Beamex contact information plus the Model number, serial number, min and max range and the native pressure units of the internal sensor, date of calibration and the software version installed. This screen contains information only and does not contain any interactive keys.



Figure - Setup Info

## 7.8.5 Setup Service

The setup service screen is password protected. One password for sensor related settings and another password for regulator related settings. The first one is user configurable and the other is fixed.

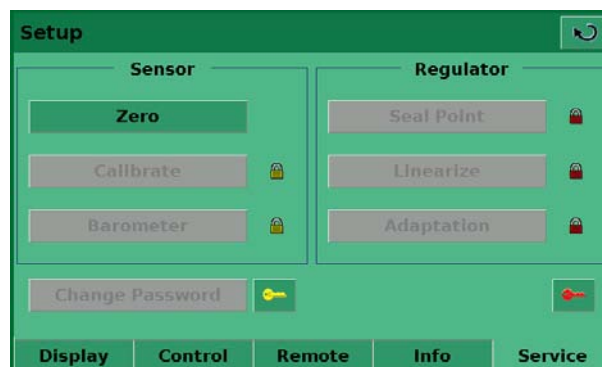



Figure - Setup Service

The setup service screen allows zero adjustment without entering the password. Press the **[Zero]** button to zero the pressure sensor.

To access the password protected portions of the setup service screen, press the  and/or the  key. This opens a password entry screen, Figure - "Password", where the password can be entered. Entering the password will open the setup service screen, Figure - "Setup Service, All Unlocked", and allow access to all the setup options.

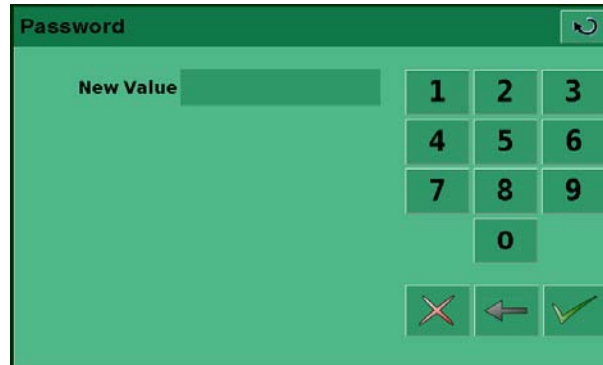

Figure - Password



Figure - Setup Service, All Unlocked

After the password for regulator related settings has been entered the Setup Service screen allows access to the Calibrate, Seal Point, Linearize, and Adaptation screens.



**Consult factory before changing any Seal Point, Linearization or Adaptation parameters.**

Press the **[Calibrate]** key to access the calibrate screen, Figure - "Calibrate Data".

The screenshot shows the 'Calibrate' screen with the following data and controls:

Serial Number	780005	99.701 kPa
Zero	-1.555	Measure Vent
Span	1.000000	Restore Factory Cal
Date of Calibration	09/18/2008	OK

At the bottom, there are three tabs: Data, Edit, and Calibrate.

Figure - Calibrate Data

The Calibrate screen contains three tabs: Data, Edit and Calibrate. When entering the calibrate screen the first time the Data Screen is the default. The Data screen allows changes to be made to the Zero, Span, Date of calibration and displays the sensor reading.

The screen accessed by pressing the **[Edit]** Tab, Figure - "Calibration Edit", allows calibration using data available from a previous calibration. An example of this is when an As-Found calibration is performed and the applied and measured pressures from the calibration are available. The low true pressure should be less than 20% FS and the high true pressure should be greater than 80% FS for best results. To edit the calibration from known data, enter the applied pressures in the Desired column and the measured pressures in the Actual column by pressing the number to be adjusted. When the values are changed, a new key "Apply" will appear on the screen. Press the Apply key to save the calibration data.

The screenshot shows the 'Calibration Edit' screen with the following data and controls:

	Desired	Actual	
1	0.00	-0.04	14.48 PSI Measure Vent
2	361.31	361.30	

At the bottom, there are three tabs: Data, Edit, and Calibrate.

Figure - Calibration Edit

The Screen accessed by pressing the **[Calibrate]** tab, Figure - "Calibrate", allows the operator to perform a live calibration while connected directly to a primary standard. In this mode, POC6 will display the currently measured pressure in the Actual column when the measured pressure is within a few percent of the value in the Desired column. The Desired column allows the actual pressures applied to POC6 to be entered. Press the Apply key to save changes. For best results, the two points should be as near the endpoints of the sensor's calibration as possible. When calibrating an absolute transducer, set the low calibration point at or above a pressure of 300 millitorr. At or above that pressure the system will have a viscous flow so that the entire system should have the same pressures after a few minutes.



Figure - Calibrate



## 8 Remote Operation

When the instrument is turned on, BIOS routines test the system CPU board. These tests may take up to 60 seconds. After the BIOS tests, LINUX is loaded. LINUX will then call the executable file via a batch file. The executable file will go through a series of software and hardware initialization. The following hardware/software is initialized:

- Transducer: The system transducer is initialized. The transducer RAM data is transferred to system RAM.
- GPIB: The GPIB board is initialized as a talker/listener.
- Units: The scale factors for percent full scale and counts are calculated.
- USB: The external USB port is initialized.
- Valves: The pressure control algorithm is initialized.
- Options: Any optional hardware/software is initialized.
- Interrupts: Interrupt vectors are loaded and enabled.
- After initialization, the program enters a polled loop.
- The proprietary calibration constants and current settings are stored in a non-volatile device.

## 8.1 Remote Setup

To setup any of the remote communication protocols start in the setup remote screen, Figure - "Setup Remote".

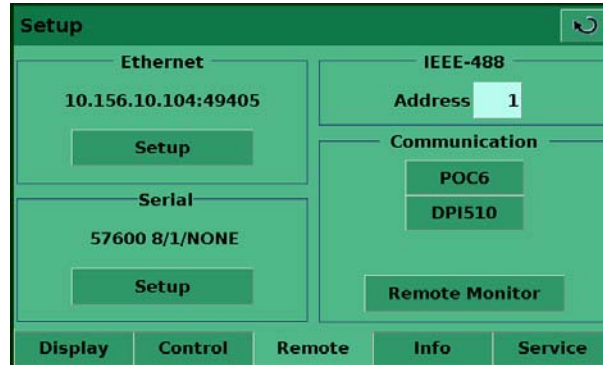

Figure - Setup Remote

## 8.2 Remote Setup – Ethernet

The Ethernet communication port allows POC6 to communicate with computers using 10/100Bases-T specification. Ethernet communications are transmitted over a standard RJ-45 cable. Connecting directly to a PC requires a crossover Ethernet cable. Hub or router connections require a straight Ethernet cable.

Before using Ethernet communication, four parameters must be set up: IP, Netmask, Gateway and Port. In Figure - "Ethernet Setup" the Ethernet setup screen is shown. Each value entry key opens an alpha or numeric data entry screen to change values of the Ethernet parameters.

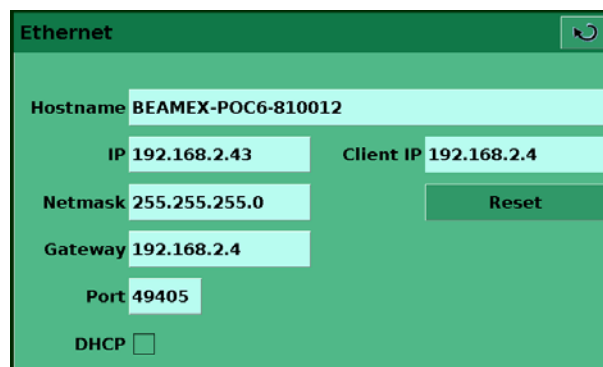

Figure - Ethernet Setup

---

## 8.3 Remote Setup – USB

The USB communication port allows POC6 to communicate with computers using a USB cable. The connection on the back panel of POC6 is a Type B receptical.

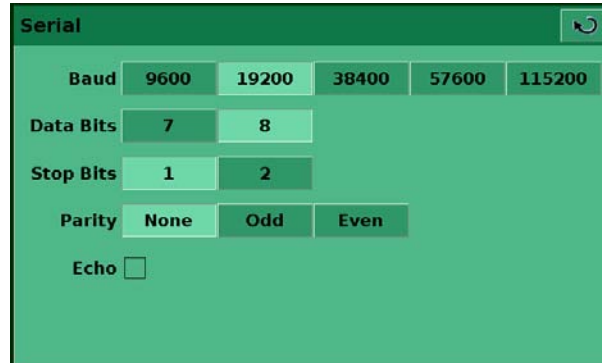

Figure - USB Setup

---

## 8.4 Remote Setup – IEEE-488

The IEEE-488 communication port allows POC6 to communicate with computers using an IEEE-488 cable. This screen, Figure - "IEEE-488 Address", is accessed by pressing the IEEE-488 numeric value box in the Setup Remote screen. After pressing the numeric value box a number entry keypad will appear for entering the new IEEE-488 address. The manufacturer of the host IEEE-488 interface board provides software to allow communication between the board and various programming languages. An interactive program for debugging is usually provided as well. Refer to the board manufacturer's documentation for more information.

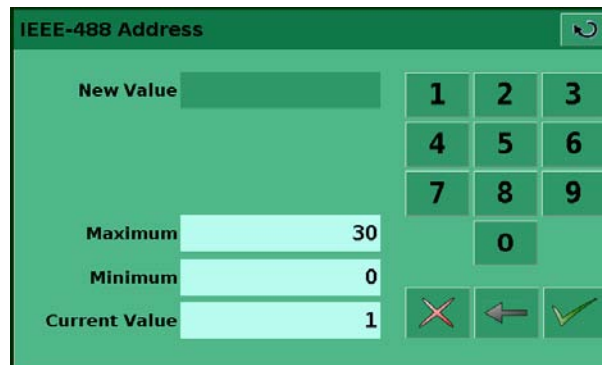

Figure - IEEE-488 Address

## 9 Troubleshooting Measures



If faults cannot be repaired, the system must be taken out of operation immediately and protected against unintentional restarting. This information should be reported to authorized service personnel.

Repairs must only be performed by Beamex or authorized service personnel.

Work on electrical or pneumatic/hydraulic equipment must only be performed by qualified and authorized service personnel, observing the corresponding safety regulations.

### 9.1 Fault Description and Measures

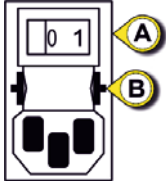
Type of Fault	Measures
I. After the system is switched 60 seconds, no measurement(s) appears, and the entire area of the screen is white or dark.	Switch off the system and then switch back on again after 5 seconds.
II. The screen is dark and the measures for faults of type I are without effect.	Check that the power cable is connected properly and have authorized technical staff check that the supply voltage is correct.
III. The screen is dark and the measures for faults of type II are without effect.	<p>First pull out the power cable from the power socket and then from the power supply input socket of the system. Then pull out the fuse holder and check the fuses.</p> <p><b>A:</b> Power supply input socket <b>B:</b> Fuse holder</p> 
IV. Malfunction during operation	Switch off the system and switch on again after 5 seconds.
V. The set value is not reached.	Check whether the value of the supply pressure at the SUPPLY HIGH port is the value required and leak-test the pipe connections.



**Warning**

**If the fuses of the power supply input socket have to be replaced, use 1.5 A, 230 VAC only.**

If you require further help please contact Beamex.

# 10 Re-calibrating and Servicing

We recommend having the system re-calibrated by the manufacturer at regular intervals of approximately 12 months. Every re-calibration at the factory also includes a comprehensive and free checking of all system parameters.

POC6 requires almost no maintenance, because all moving parts are extremely robust. There are no parts which have to be serviced by the user.

During each re-calibration the function of the integrated relief valves are checked and the lithium battery in the processor board (which is only essential for the time and date) is changed if necessary.



Warning

**Before cleaning the surface of the instrument, make sure the instrument is not pressurized, that the power is off and the power supply has been disconnected.**



Caution

**To clean the touch-screen use only customary plastic or glass cleaning agents in compliance with the guidelines of the manufacturer.**

# 11 Removal of the Instrument



Work on electrical or pneumatic/hydraulic equipment must only be carried out by qualified and authorized service personnel, observing the corresponding safety regulations.

## When dismantling the system proceed as follows:

- 1 Make sure that there is no positive or negative pressure on the system and that all parts of the instrument are at room temperature.
- 2 Switch the system off by pressing the power switch located at the rear of the instrument.
- 3 First pull out the power cable from the power socket and then from the power supply input.
- 4 Disconnect the pressure connections.



If a connection to a SWAGELOK<sup>®</sup> -connection is to be disconnected, overturning or loosening the SWAGELOK<sup>®</sup> - connection must be prevented with suitable tools.

- 5 Remove the system as necessary.
- 6 Protect connections with the protective caps supplied.

# 12 Transport of the System



**Warning**

**Before the system is shipped it must be clean and free of dirt and debris. This is particularly important if the medium is a health hazard such as a corrosive, toxic, carcinogenic, radioactive, etc.**

The precision measuring system POC6 must only be shipped in an appropriate transport box. If necessary, please ask for a proper transport box.

## **Follow the instructions below to prevent damage.**

- 1 Wrap the system in anti-static plastic foil.
- 2 Place the system in the box assuring the instrument is packed tight with insulating material surrounding the instrument on all sides.
- 3 If possible add a bag of desiccant to the box
- 4 Make sure that the shipment is marked as transport of a highly sensitive measuring instrument.

## **The shipping address is:**

Beamex Oy Ab  
Ristisuonraitti 10  
FI-68600 Pietarsaari  
FINLAND

Tel +358 - 10 - 5505000  
Fax +358 - 10 - 5505404  
E-mail: [sales@beamex.com](mailto:sales@beamex.com)  
Internet: [www.beamex.com](http://www.beamex.com)



# 13 Storage of the System



**Before the system is stored it must be clean and free of dirt and debris. This is particularly important if the medium is a health hazard such as a corrosive, toxic, carcinogenic, radioactive, etc.**

**The storage place must satisfy the following conditions:**

- Storage temperature: 0 to 70 °C
- Humidity: 35 to 85% relative humidity without condensation

**Avoid the following influences:**

- Direct sunlight or vicinity to hot objects
- Mechanical vibration
- Soot, steam, dust and corrosive gases
- Explosion-hazard environment, flammable atmosphere

The system should be stored in its original transport box, in a place that meets the conditions listed above.

**Follow the instructions below to avoid damage.**

- 1 Wrap the system in anti-static plastic foil.
- 2 Using the insulating material, place the system in the box.
- 3 If the system is stored for a longer time (more than 30 days) add a bag with desiccant to the box.

# 14 Placing Out of Service



**Warning**

**Before the system is placed out of service it must be clean and free of dirt and debris. This is particularly important if the medium is a health hazard such as a corrosive, toxic, carcinogenic, radioactive, etc.**

When placing the system out of service, please dismantle it according to the instructions in the manual in section 11: "Removal of the Instrument".



**Notice**

When disposing of the system please observe the legal and local regulations in force.

For the final disposal of the system a special firm qualified for this is to be commissioned.

# 15 Appendix

Table – Measurement Units

Table – Conversion Factors, Pascal

## 15.1 Measurement Units

The Units command selects the measurement units to be output on the bus and the display.

**Table – Measurement Units (unit no)**

Code	Description	Output Format
1	pounds per square inch	psi
2	inches of mercury @ 0 °C	inHg 0 °C
3	inches of mercury @ 60 °F	inHg 60 °F
4	inches of water @ 4 °C	inH2O 4 °C
5	inches of water @ 20 °C	inH2O 20 °C
6	inches of water @ 60 °F	inH2O 60 °F
7	feet of water @ 4 °C	ftH2O 4 °C
8	feet of water @ 20 °C	ftH2O 20 °C
9	feet of water @ 60 °F	ftH2O 60 °F
10	millitorr	mTorr
11	inches of seawater @ 0 °C 3.5 % salinity	inSW
12	feet of seawater @ 0 °C 3.5 % salinity	ftSW
13	atmospheres	atm
14	bars	bar
15	millibars	mbar
16	millimeters of water @ 4 °C	mmH2O 4 °C
17	centimeters of water @ 4 °C	cmH2O 4 °C
18	meters of water @ 4 °C	mH2O 4 °C
19	millimeters of mercury @ 0 °C	mmHg 0 °C
20	centimeters of mercury @ 0 °C	cmHg 0 °C
21	torr	Torr
22	kilopascals	kPa
23	pascals	PA
24	dyne per square centimeter	dy/cm <sup>2</sup>
25	grams per square centimeter	gm/cm <sup>2</sup>
26	kilograms per square centimeter	kg/cm <sup>2</sup>
27	meters of seawater @ 0 °C 3.5 % salinity	m SW
28	ounce per square inch	OSI
29	pounds per square foot	PSF
30	tons per square foot	TSF
31	percent of full scale	% FS
32	micron HG @ 0 °C	µHg 0 °C
33	ton per square inch	tsi
34	n/a	n/a
35	hectopascals	hPa
36	megapascals	MPa
37	millimeters of water @ 20 °C	mmH2O 20 °C
38	centimeter of water @ 20 °C	cmH2O 20 °C
39	meters of water @ 20 °C	mH2O 20 °C
n/a	User Units 1	User defined
n/a	User Units 2	User defined

## 15.2 Conversion Factors, Pascal

The following table lists factors which should be used as multipliers when converting other pressure units to or from Pascal.

**Table – Conversion Factors, Pascal**

Unit No.	Pressure Unit	To Convert from Pascal	To Convert to Pascal
1	psi	1.450377E-04	6.894757E+03
2	inHG @ 0 °C	2.952997E-04	3.386390E+03
3	inHG @ 60 °F	2.961339E-04	3.376850E+03
4	inH2O @ 4 °C	4.014741E-03	2.490820E+02
5	inH2O @ 20 °C	4.021862E-03	2.486410E+02
6	inH2O @ 60 °F	4.018645E-03	2.488400E+02
7	ftH2O @ 4 °C	3.345622E-04	2.988980E+03
8	ftH2O @ 20 °C	3.351551E-04	2.983692E+03
9	ftH2O @ 60 °F	3.348871E-04	2.986080E+03
10	mTORR	7.500636E+00	1.333220E-01
11	inSW @ 0 °C 3.5% sal	3.904899E-03	2.560885E+02
12	ftSW @ 0 °C 3.5% sal	3.254082E-04	3.073062E+03
13	atm	9.869230E-06	1.013250E+05
14	bar	1.00000E-05	1.00000E+05
15	mbar	1.00000E-02	1.00000E+02
16	mmH2O @ 4 °C	1.019744E-01	9.806378E+00
17	cmH2O @ 4 °C	1.019744E-02	9.806378E+01
18	mH2O @ 4 °C	1.019744E-04	9.806378E+03
19	mmHG @ 0 °C	7.500636E-03	1.333220E+02
20	cmHG @ 0 °C	7.500636E-04	1.333220E+03
21	TORR	7.500636E-03	1.333220E+02
22	KPA	1.00000E-03	1.00000E+03
23	Pa	1.00000E+00	1.00000E+00
24	DYNE/SQ cm	1.00000E+01	1.00000E-01
25	g/sq cm	1.019716E-02	9.806647E+01
26	kg/sq cm	1.019716E-05	9.806647E+04
27	mSW @ 0 °C 3.5% sal	9.918444E-05	1.008222E+04
28	OSI	2.320603E-03	4.309223E+02
29	PSF	2.088543E-02	4.788025E+01
30	TSF	1.044271E-05	9.576052E+04
32	MICRON HG @ 0 °C	7.500636E+00	1.333220E-01
33	TSI	7.251885E-08	1.378951E+07
35	hPA	1.00000E-02	1.00000E+02
36	MPA	1.00000E-06	1.00000E+06
37	mmH2O @ 20 °C	1.021553E-01	9.789017E+00
38	cmH2O @ 20 °C	1.021553E-02	9.789017E+01
39	mH2O @ 20 °C	1.021553E-04	9.789017E+03





