

MC5P

MULTIFUNCTION CALIBRATOR



User Guide

Applies for Main Firmware version 1.95

Dear user,

We have made every effort to ensure the accuracy of the contents of this manual. Should any errors be detected, we would greatly appreciate to receive suggestions to improve the quality of the contents of this manual.

The above notwithstanding, we can assume no responsibility for any errors in this manual or their eventual consequences.

We reserve rights to make modifications to this manual without any further notice.

For more detailed technical data about the MC5 Multifunction Calibrator, please contact the manufacturer.

© Copyright 2003, 2006

BEAMEX OY AB

Ristisuonraitti 10

FIN-68600 Pietarsaari

FINLAND

Tel +358 - 10 - 5505000

Fax +358 - 10 - 5505404

E-mail: sales@beamex.com

Internet: <http://www.beamex.com>

8824000 / UEMC5P / 000696

Trademarks

QCAL® is a registered trademark owned by Oy Beamex Ab.

HART® is a registered trademark of the HART Communication Foundation.

Any use of the word "HART" hereafter in

this document implies the registered trademark.

Other trademarks are property of their respective owners.

Contents

Part A, General

Introduction	2	MC5P's Modularity and Options	20
About This Manual	2	Hardware modules/options	20
Typographical Conventions	3	Other Connectable devices	21
Unpacking and Inspection	3	Firmware options	21
MC5P Hardware	4	Safety	22
Operational Sections and Connections ..	4	Certifications and Compliances (EC	
Base Unit and the Display	5	Declaration of Conformity)	22
Electrical Module (E module)	5	Safety Precautions and Warnings	23
Electrical and Temperature Module		General Warnings	23
(ET module)	6	Warnings Concerning the use of	
Reference Junction Module	6	Electrical Modules (E and ET)	24
Internal Pressure Modules	7	General Warnings Concerning	
External Pressure Modules	7	Pressure Measurement	24
Environment Temperature Interface .	7	Warnings Concerning	
Computer/Printer Interface	8	High Pressure	25
Auxiliary Instrument Interface	8	Service	26
Keyboard	9	Firmware Update	26
Memory	10	Recalibrating MC5P	26
Power Supply	10	The Battery Charger	26
MC5P Firmware	11	Cleaning MC5P	27
General Description	11	Cleaning the Contacts of	
Startup Procedure	11	the Internal Reference	
Basic Mode	12	Junction Module	27
Maintenance	12		
Calibration Mode	12		
Help Function	13		
Printing	13		
The User Interface	14		
The Status Bar	14		
The Function Key Bar	15		
Menus	15		
The Display Area	16		

Part B, Startup and Basic Operation

Starting MC5P	30	Generating/Simulating	54
Startup Procedure	30	General	54
Basic Mode, Defined	31	Changing the Value of the Generated/Simulated Signal	55
Measuring	33	Current Generation	56
Pressure Measurement	35	Using the ET module's output terminals	56
Using Internal Modules	35	Using the E module's output terminals	56
Using External Modules	35	Voltage Generation	58
Zeroing a Pressure Module	36	Generating Voltages up to ± 12 V	58
Current Measurement	37	Low Voltage Generation	58
External supply	37	Frequency Generation	60
Internal Supply	37	Pulse Generation	61
Voltage Measurement	38	RTD and Resistance Simulation	62
Measuring Low Voltages	38	Thermocouple Simulation	63
Measuring Voltages up to ± 50 V	39	Internal Reference Junction	63
Resistance Measurement	40	External Reference Junction	63
Switch State Sensing	41	Special Generations	65
Limit Switch Test	42	Opening the Step or Ramp	
Performing the Limit Switch Test	42	Configuration Window	65
Frequency Measurement	44	Stepping	66
Pulse Counting	45	Ramping	67
RTD Measurement (Temperature)	46	Alarm Limit Settings	69
Thermocouple Measurement (Temperature)	47		
Internal Reference Junction	47		
External Reference Junction	47		
Special Measurements	49		
Mathematical Special Measurements ..	50		
Minimum value	50		
Maximum value	50		
Min/Max value	50		
Rate of Change	50		
Special Filtering and Resolution	51		
Deviation Measurement	51		
Special Measurements Using			
Two Ports Simultaneously	52		
Difference Measurement	52		
Redundant Measurement	53		

Part C, Advanced Operation and Configurations

Configuring the Calibrator	72	Additional Information	90
Settings	72	Things to Consider when Measuring	
Setting Time and Date	74	Pressure	91
Advanced Utilities	75	General	91
Measuring the Environment		Pressure Type	91
Temperature with the ENV Sensor	75	Pressure Modules and	
Display Mode Settings	76	their Naming Conventions	92
Scaling	77	Square Rooting	92
Displaying Values in Percentage	78	Thermocouple	
Displaying Error Values	78	Measurement/Simulation,	
Transmitter/Switch Simulation	79	Connections and Troubleshooting	93
Transmitter Simulation	80	Internal Reference Junction	93
Switch Simulation	81	External Reference Junction	94
Data Logging	82	Error situations	96
General	82	Resistance and RTD	
Configuring	82	Measurement, Connections	97
Starting the Data Log	83	4-wire System	97
Viewing the Results	84	3-wire System	97
Transferring the Results to		Using a Compensation Loop	98
a Personal Computer	84	2-wire System	98
Generating Signals Using External		Current Measurement Parallel to	
Devices	85	a Test Diode, Connections	99
Controlling the External Device		Parallel Functions in MC5P	100
in Basic Mode	86		
Pressure Controller Settings	87		
Temperature Controller Settings	88		
Printing	89		

Part D, Calibration

General	102	Using External Devices in Calibration Mode	122
Phases of Instrument Calibration	103	MC5P's Support for Instrument Adjustment	123
As Found Calibration	104		
Adjustment	104		
As Left Calibration	105		
Required Modules for Different Input/Output Signal Combinations	106		
Calibrating an Instrument	108	Maintaining MC5P's Instrument Database	124
Selecting the Instrument to Be Calibrated	108	Adding New Instruments	124
The Instrument Window	109	Editing Instrument Data	125
A Calibration Procedure		General Data Page	125
Using MC5P	110	Instrument Input Page	126
About Automatic Calibration	112	Instrument Output Page	127
About Manual Calibration	112	Calibration Settings Page	127
Autocapture Feature	113	Calibration Instructions Page	128
Examples of Instrument Calibration ...	113	Deleting Instruments	128
Pressure Transmitters and Sensors	114	Viewing Calibration Results	129
Temperature Sensors	116	Calibration Result Windows	130
Temperature Indicators and Recorders	118	How to Choose Which Calibration Run is Viewed	130
Electrical Limit Switches	120	Deleting Calibration Results	130

Appendix 1, User Guide for MC5P HART Option	132
Appendix 2, Technical Data	146
Appendix 3, Quick Guide for the MC5 Datalog Viewer	154
Appendix 4, Index	156

Feedback

We want to improve our products and services constantly. Therefore we'd like to know Your opinion of the product You use. Please spend a moment of Your valuable time in filling this form. All respondents will receive a surprise gift in return.

Certain questions can be answered immediately after receiving the product. Others require some use of the product before You are able to answer them. The best way to fill the form is to answer the items as it applies, and send the form to us when all items are answered. There are however no definite restrictions; fill in the form when you feel like it (all items need not be answered). Then send it to Beamex using one of the possibilities listed below.

Mail: **Beamex Oy, Ab**
Quality Feedback
Ristisuonraitti 10
FIN-68600 Pietarsaari
FINLAND

Fax **+358 - 10 - 5505404**
Only the next page need to be faxed to us.

Internet: **<http://www.beamex.com>**
A similar form is available as a web page

E-mail: **support@beamex.com**
Refer to the numbered items on the next page in Your e-mail message.

1. Name of the product you give feedback of: _____

2. Serial number and software version number (if applicable) _____

3. Any comments when receiving the product. Did the package contain all required items and was it as expected?

4. For how long have you been using the product? _____

5. How helpful was the manual in using the product?

(Tick a box in the percentage scale below)

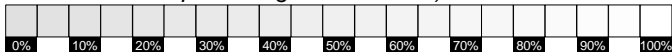

6. How well did the product suit your needs?

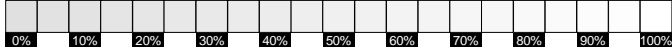

7. How satisfied are you with the product?

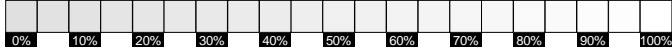

8. Did anything in the product exceed your expectations? In that case, what was it?

9. Did anything in the product disappoint you? In that case, please specify.

10. Any ideas You want to propose to Beamex so that we can improve our products, operations and/or services.

Please fill in these fields in order to receive your surprise gift.

Title & Name:

Address:

Please contact me concerning the Feedback I have given.

I want to receive more information on Beamex products.

Size (tick one)
XS S M L XL XXL

A General

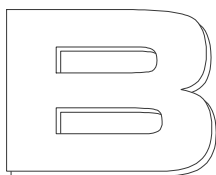
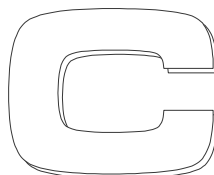
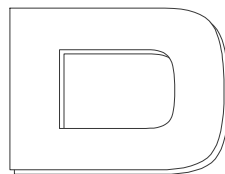

Things discussed in Part A:

- An introduction to what MC5P is and what the parts of this User Guide concentrate on.
- A general description of MC5P's hardware.
- A general description of MC5P's firmware.
- The modularity and options of MC5P.
- Safety precautions and warnings.
- Briefly about how to service MC5P.

Introduction

Congratulations for selecting the ultimate calibration tool!

MC5P is a panel mounted documenting All-In-One Multifunction Calibrator with calibration capability of pressure, temperature, electrical and frequency signals. As a member of Beamex's QCAL Quality Calibration family it is of course able to communicate with the available QCAL calibration software.

MC5P's modularity allows customized construction. If requirements increase in the future, new functionality may be added by getting additional modules, e.g. adding temperature and/or electrical modules to an MC5P that previously only included pressure modules.

Thanks to the logical user interface MC5P is very easy to use. The large backlit graphical display guides the user in different languages and it displays results both numerically and graphically.

MC5P performs automatic calibration of pressure, electrical and temperature process instruments. It is capable of communicating with external devices such as pressure controllers. MC5P also communicates with HART field instruments.

MC5P represents the state of the art in accuracy, adaptability and all-round usability.

About This Manual

This User Guide is divided in four parts: A, B, C and D.

- Part A discusses general matters. There is also a chapter about safety.
- Part B describes the basic use of MC5P such as measuring and generating signals.
- Part C handles configuration level usage, some optional software utilities and also offers some additional information concerning pressure measurement, RTD and T/C measurement/simulation.
- Part D concentrates on calibration and matters related to calibration like handling instrument data

The even page header displays the title of the active part. The odd page header displays the main subject (Heading level 1).

The header of each odd page also indicates the active part as shown in the adjacent picture (with Part B

active). Use the information provided in the headers as a quick guide when searching for a particular subject.



Typographical Conventions

All examples of user interface texts are printed using 8 pt Arial Black, e.g.

Selected port: ET: TCI(meas)

All front panel texts (fixed texts on MC5P's cover) are printed using 8 pt Eurostile, e.g.

Connectors marked T/C, Low V

Function and Menu keys are often referred to using both the key name in 8 pt Eurostile and the corresponding text (function) displayed on the screen in 8 pt Arial Black, e.g.

Function key D/Menu

Unpacking and Inspection

At the factory each new MC5P passes a careful inspection. It should be free of scrapes and scratches and in proper operation order upon receipt. The receiver should, however, inspect the unit for any damage that may have occurred during transit. If there are signs of obvious mechanical damage, package contents are incomplete, or the instrument does not operate according to specifications, contact the purchasing sales office as soon as possible. The standard accessories are as follows:

- Calibration Certificate
- This User Guide
- Warranty Card
- Computer communication cable
- If any internal **pressure modules** are present:
 - A pressure hose set
- Two test leads and clips
- If the **ET module** is present: Four additional test leads and two clips

For a description of available hardware and software options, see **MC5P's Modularity and Options** on page 20.

If you have to return MC5P to the factory for any reason, pack it carefully. Include a detailed description of the reason for the return.

Warning!

The accessory polyurethane hose supplied with the calibrator is rated to the maximum pressure of 20 bar at 21°C (290 psi at 70°F). Applying higher pressure can be hazardous.

MC5P Hardware

General features:

- Operating temperature: 0 ... +40 °C (32 ... 104 °F).
- Storage temperature: -20 ... +60 °C (-4 ... 140 °F).
Note: The stickers may be affected when storing longer periods in extreme conditions.
- Pressure media for pressure modules: Clean, dry and oil free instrument air
- Humidity: 0 ... 80 %RH

More comprehensive specifications are available in Appendix 2.

Operational Sections and Connections

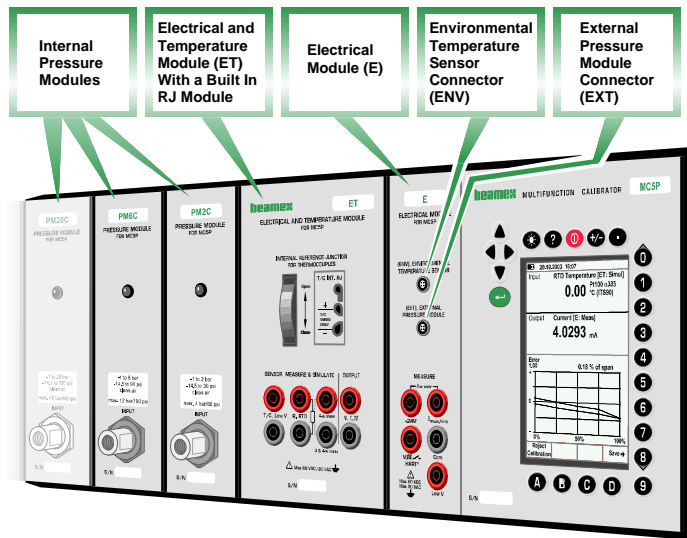

All sections and connections are presented in detail on the next pages.

Note.



Keep in mind that the previous picture (as well as all pictures of MC5P in this manual) has an example configuration of modules. The configuration of your MC5P may vary significantly from the one in the picture.

Base Unit and the Display



All MC5P's are shipped with the Base Unit containing the keyboard and the display. It contains the main processor which communicates both with the user and all other modules. The Base Unit is seen on the right side of the previous picture.

MC5P has a backlit transreflective display. The resolution of the display is 240 x 320 pixels.

To quickly tune the contrast of the display:

- Press and hold the light button  down.
- Use the up  and down  arrow keys to change the contrast.

To quickly tune the backlight brightness:

- Press and hold the light button  down.
- Use the left  and right  arrow keys to change the backlight brightness.

The changed settings are automatically saved as default settings.

The keyboard is described on page 9.

Electrical Module (E module)

The E module is joined with the Base Unit. The E module can measure the following quantities: **voltage, current and frequency**. It can also be used when counting **pulses** or detecting the state of a **switch**. Additionally there is a possibility to **generate current** and supply an instrument with a 24 VDC power supply.

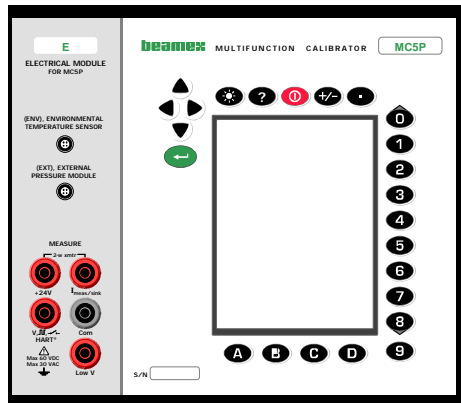

The E module also includes the HART modem needed when utilizing the HART communication option. The modem (together with the HART communication option) allows communication with an instrument with HART capabilities. When HART is used in conjunction with MC5P's 24 volt power supply, an internal 270 ohm resistor needed for HART communication is automatically included.

Additional information on calibrating HART instruments is in Appendix 1.

Electrical and Temperature Module (ET module)

The ET module is specially designed for temperature instrument calibration needs. It is not however restricted to only temperature instrument use because it can also generate **voltage, current, frequency and pulses**.

Measuring capabilities:

- Low Voltage measurement and T/C measurement using either the internal reference junction or the Low Voltage connectors.
- Resistance and RTD measurement.

Generation/simulation capabilities:

- T/C simulation using either the internal reference junction or the Low Voltage connectors.
- Resistance and RTD simulation.
- Voltage, current, frequency and pulse generation

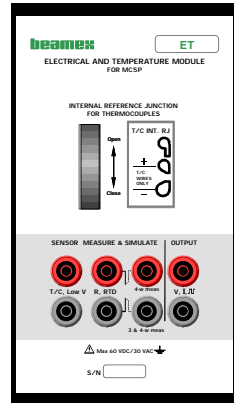

Reference Junction Module

The T/C measurement/simulation internal reference junction is an additional part of the ET module. It is specially designed for MC5P and therefore best suited for reference junction compensation when calibrating thermocouples or instruments connected to a thermocouple.

The Reference Junction Module is suited for all standard T/C plugs and stripped wires. Open the fixing screw on the left side of MC5P before connecting the wires/plug to the Reference Junction Module. Make sure to connect the wires/plug as the polarity is indicated on the Reference Junction Module. Remember to tighten the fastening screw when the wires/plug are connected. Hand tightening is adequate. Do not pull out the wires/plug without first opening the fixing screw. Otherwise you might damage the contact surface of the connectors.

T/C measurement and simulation may also be done without the internal reference junction by using the Low Voltage terminals in the ET module. Then the reference junction arrangements have to be done outside MC5P and the correct reference junction settings

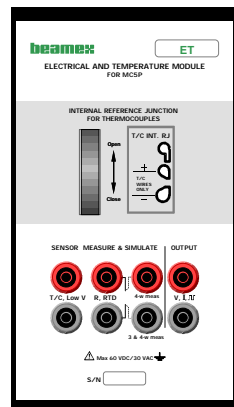

as well as the reference junction temperature have to be informed to MC5P. More of reference junction connections in part C of this manual.

Internal Pressure Modules

Internal Pressure Modules are Pressure Modules installed into the same rack as MC5P and are connected to MC5P via communication cable inside the rack. Up to nine Internal Pressure Modules may be connected to MC5P. One of them may be an internal barometric module.

The recommended pressure medium for all internal pressure modules is clean air. Clean non-corrosive liquids may optionally be used in modules with a measuring range of 20 bar/300 psi or more. Avoid spilling liquid on MC5P when connecting/disconnecting pressure hoses to/from pressure modules.

To avoid damaging the module, use hand tightening only when connecting the pressure measurement hoses (max. torque 5 Nm, approx. 3.6 lbf ft). If the use of tools is required to secure the connection (typically pressure modules with a pressure range higher than 20 bar), apply the counterforce by placing a 14 mm (approx. 9/16") A/F spanner on the flats found in the module's connector.

The overpressure protection of the internal pressure modules vents to the inside of the module rack. Remember to be cautious when working with pressure and pressure modules. See also chapters **Safety** on page 22 and **Safety Precautions and Warnings** on page 23.

Installing and removing Pressure Modules is described in the MCS100 User Guide.

External Pressure Modules

MC5P has a connector for External Pressure Modules (EXTs). The connector is located in the E module section of MC5P.

Environment Temperature Sensor Interface

This connector is also located in the E module section of MC5P. It is meant to be used with an optional temperature measurement sensor. The sensor is only meant for environment temperature measurement. It should not be used as a reference sensor when calibrating temperature instruments.

Computer/Printer Interface

The location of the Computer/Printer connector varies depending on the configuration of the MCS100 calibration station which MC5P is part of. In some cases the connector is on the rear side of the rack. In other cases in the front of the rack. Whatever the location of the connector is, it is marked with the text “COMP/PRT”.

The COMP/PRT connector may be used when connecting to a serial port in a PC. The PC may have a calibration software capable of communicating with MC5P or, e.g. a software that reads data logging results in MC5P and transfers them to a PC.

The same connector can be used when MC5P is connected to an optional portable printer. The printer may be used for printouts of user interface screens (e.g. calibrations results).

Warning!

Use only cables provided by Beamex when connecting MC5P to a PC or a printer.

Auxiliary Instrument Interface

The location of the Auxiliary Instrument connector also varies depending on the configuration of the MCS100 calibration station which MC5P is part of. The connector is however marked with the text “AUX”.

The AUX connector is used when connecting pressure controllers, temperature baths/dry blocks etc. to MC5P.

Using auxiliary instruments is described in Part C of this manual.

The front panel has several sections. Some of them are pointed out with a callout in the picture of Operational Sections and Connections, and some of them not (e.g. display and keyboard). The ones with a callout are discussed first in the following paragraphs.

Part B of this manual describes in detail what kind of reference junction settings are available.

Keyboard

The keys on the MC5P's keyboard are grouped according to their function as follows:

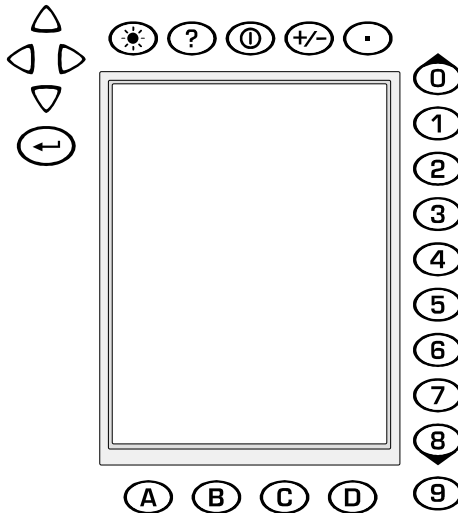

The Cursor Keys and the Enter Key

The Cursor keys and the Enter key are located close to the upper left corner of the display. The Cursor keys are used when moving the cursor on the screen. They also have several special functions in certain situations, e.g. when tuning the contrast of the display. The Enter key finishes the entering of values.



The Light key toggles the back light of the display on and off. It is also used when setting the contrast and the brightness of the display (see chapter **Base Unit** on page 5) and when printing screenshots (see chapter **Printing** on page 13).



The Help key displays case sensitive help.



The On/Off key switches MC5P on and off. Press the On/Off key for about half-a-second to switch on/off. This delayed function prevents accidental on/off switching of MC5P.



Pressing the +/- key toggles the sign of the entered numeric value. Note. The +/- key is applicable only in numeric fields.



The Decimal key adds the decimal point to the numeric value that is currently edited.

The Function Keys



The Function Keys are located below the display. The meaning of each Function Key varies depending on the situation. The lower part of the display indicates what the Function Key stands for at the moment.





The Numeric Keys



The Numeric keys are not only used when entering numbers:



- Keys 1 to 7 are used as menu selector keys.
- Keys 0 and 8 are used to scroll through several pages of menu options. They may also be used when browsing through options in a pop-up list.
- Key 9 can be used when accepting a selection or when finishing a data entry. The functionality of the 9 key is almost similar to the  key, except for one situation: When entering numbers, the 9 key produces the number 9. To finish entering a number, you will have to use the  key or use the D/OK Function Key when available.



Memory

MC5P has a dynamic memory allocation system. This means that there is not a specific area of memory reserved for, e.g. instrument data. All free memory may be used for anything that requires more memory. Thus there is no exact limit for the number of instruments that MC5P can maintain in its memory. It all depends on how much memory is allocated by other data.

Power Supply

MC5P is connected to a socket output inside the MCS100 module rack. A more detailed description of power supplies is in the MCS100 User Guide.

Notes.

MC5P's memory and the internal clock/calendar uses a small amount of power although the calibrator is switched off. Do not leave MC5P without power for too long. MC5P may lose its settings if it is left without a support voltage for an extended period.

MC5P Firmware

MC5P's firmware is saved in FLASH memory. Therefore it is relatively easy to update the firmware whenever a new version with fresh capabilities is released. See **Firmware Update** on page 26 for more information on updating the firmware in your MC5P.

General Description

The following picture shortly describes the functions of the firmware. All main functions are marked with a black border. Each main function has several tasks which are displayed as shaded boxes without a black border.

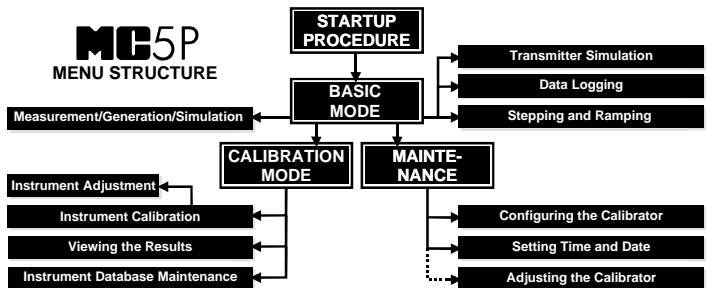

The following chapters briefly describe each main function.

Startup Procedure

Every time MC5P is started the Startup Procedure checks the functionality of the device by performing a self test.

If the self-test is passed successfully, some basic calibrator data is displayed.

After that MC5P automatically proceeds to Basic Mode. A more comprehensive description of the Startup Procedure is in the beginning of Part B of this manual.

Basic Mode

In Basic Mode you can measure and generate/simulate signals. There are two separately configurable windows available. Basic Mode is often used for testing connections before starting the actual calibration procedure of an instrument.

Stepping and Ramping tools enable generating/simulating signals that vary with time.

All main functions of Basic Mode are described in part B of this manual.

Part C concentrates on Basic Mode's higher level functions and additional information.

Maintenance

This main function handles calibrator configuration settings.

Additionally there is the possibility to recalibrate MC5P (requires a password).

Maintenance level subjects are handled in Part C of this Manual.

Calibration Mode

MC5P's main duty is calibrating instruments. Therefore very special attention was directed on this matter when creating the calibrator. MC5P may be used as a stand-alone calibrator i.e. all instrument data and calibration history data is saved in MC5P's own memory. Optionally MC5P also communicates with calibration software.

MC5P supports the use of instruction texts. They help the technician to perform the calibration as fluently as possible. You may enter three kinds of instruction texts: **Starting Guide**, **Adjusting Guide** and **Finishing Guide**. Additionally, calibration notes can be entered after the calibration procedure.

More calibration related information is available in Part D of this manual.

Calibration Results

The graphical representation as well as numeric data of the calibration results may be viewed in MC5P (and printed if the optional printer is available). Transferring the results to QCAL[®] calibration software makes it possible to view the results in PC environment.



More information concerning calibration results is presented in Part D of this manual.

Help Function

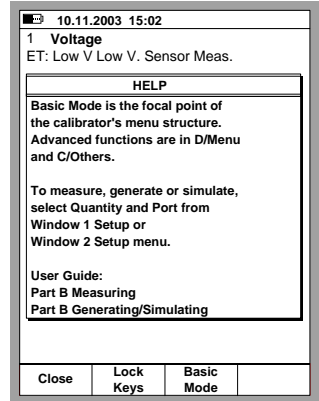
The Help function is not seen in the picture of the menu structure because it is not a separate “branch” but a utility available in almost any situation. If you need help, just press the  key. A window with related help pops up.



Printing

You can print out screenshots of any situations in MC5P by pressing the  key and the  key simultaneously.

Additional information on printing is found in part C of this manual.

Warning!

Only use the printer that is available as an option. Using any other printers may damage the printer or MC5P or even both of them.

The User Interface

The main elements of the User window can be seen in the following picture:

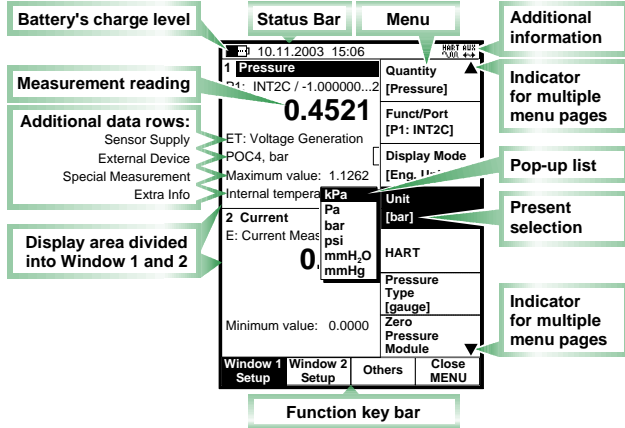

All possible elements are not included in the previous picture, but the important ones are discussed in the following chapters.

The Status Bar

The Status Bar at the top of the display is visible all the time. It is divided into four main sections.

Example of Status Bar appearance	Sections:			
	1	2	3	4
	Time & Date		21.3 °C	

The first (leftmost) section displays the charge level of the battery. The battery symbol is replaced by a plug symbol (⎓) if you are using the battery charger together with the optional Dry Battery Cartridge. In this case the battery charger acts as a battery eliminator. The second section displays the time and date. The third section displays the temperature measured with the optional environment sensor, if the sensor is connected to MC5P.

The fourth section (rightmost) section displays additional information in the form of symbols, like:

- An hourglass when MC5P is working on something that takes time.
- A question mark when an error occurred.
- A symbol indicating communication with an external device, e.g. a HART instrument or a controller (or).

Note that the fourth section is empty for most of the time. The symbols are visible only when needed.





The Function Key Bar

The Function Key Bar at the bottom of the display is visible all the time. The meaning of the Function Keys varies depending on the situation. A grayed Function key text means that the function is disabled at the moment.





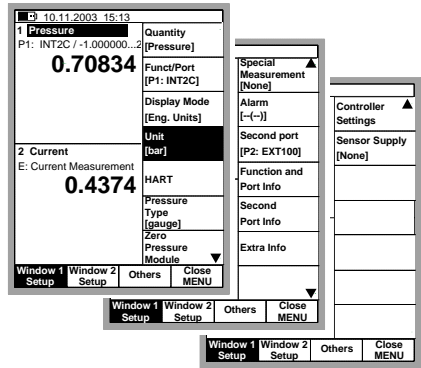

Calibration Mode	Field	Stop Ramping	MENU
------------------	-------	--------------	------

Menus

The Function Key for opening the menu is always D/Menu. The same key is used when closing the menu. If a menu is not needed for the current subject, the fourth Function Key is used for other needs.

If the opened menu has several pages, the menu's uppermost and/or lowermost item includes an up/down triangle. In that case, use the  and  keys to browse through the available menu pages. A menu option is selected with the numeric keys  to . Selecting a menu option results in one of the following events:



1. An immediate action follows and the menu closes automatically, e.g. when selecting the Zero Pressure Module option in the picture above.
2. A pop-up list opens for selecting one of the available options. The current selection is displayed inside brackets in the menu. Use the  and  keys or the  and  keys to scroll the pop-up list. To select an option in the pop-up list, use either the  key or the  key. To close the pop-up menu without selecting anything, press the  key or the D/Close Function Key.
3. Another menu with new options replaces the previous menu. Sometimes the Function Keys can also open another menu. In the previous picture, the Window 1 setup menu is opened. In this case Function Key B/Window 2 Setup and Function Key C/Others can be used for opening other menus.
4. A new window opens for, e.g. viewing additional information or for configuring the selected task.

The Display Area

The layout of the display area varies according to the needs of the active tasks/settings. The following pictures give an overview of typical elements seen in different display area layouts.

Basic Measurement/Generation:

The display area is divided into two windows with informative texts and numeric measurement/generation values.

A border surrounding a numeric value indicates that the field is editable. It is, e.g. a generation field for entering generation values.

If several editable fields are visible, choose the active field with the cursor keys or the B/Field Function Key.

Calibration:

The display area is divided into three windows during a calibration.

The first window displays data related to the instruments input signal. The second corresponding data related to the output signal.

The third window displays the error graph. The error graph is also seen among calibration result data.

Configuration Window:

There are plenty of configuration windows in MC5P. The picture beside is the configuration window for Ramping settings.

The common thing for all configuration windows is that they reserve the whole display area for the configuration fields.

Use the cursor keys to move between fields.

10.11.2003 15:04

1 Frequency
ET: Frequency Gen.

1.00000 pos. square kHz

Amplitude [Vpp] 5.00

2 Current 
E: Current Measurement

11.9837 mA

Calibration Mode	Field		MENU
------------------	-------	--	------

10.11.2003 15:04

Input RTD Temperature [ET: Simul.]

50.00 Pt100 a385 °C (ITS90)

Output Current [E: Meas.]

11.9925 mA

Error 0.40 -0.05% of span

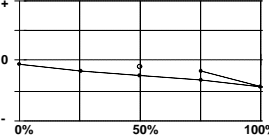

Pause	Force Accept		
-------	--------------	--	--

10.11.2003 15:04

RAMPING

Quantity Port	Current	E: (gen)
Wait in 0%	2	s <input checked="" type="checkbox"/>
Rise Time	1	s <input checked="" type="checkbox"/>
Wait in 100%	2	s <input checked="" type="checkbox"/>
Fall Time	2	s <input checked="" type="checkbox"/>
Repeats	0 = continuous <input type="text" value="1"/>	
Range	0 %	8.0000
	100 %	16.0000 mA

Cancel			Start
--------	--	--	-------

Tables:

Tables are used, e.g. when viewing calibration results in numeric format. Tables reserve the whole display area.

The tables are often larger than the display. In that case there are small arrows added to the table borders. They indicate that more information may be seen by using the arrow keys.

The Δ and ∇ keys scroll the list one line at a time. The \odot and \oplus keys scroll the list one page at a time (if applicable).

Hint.

If the table has more columns than can be seen, use the numeric keys to quickly jump to corresponding column.

Help window:

The help window is a special window. It displays help text that the user called using the $\textcircled{?}$ key.

Input	Output	Error
[V]	[V]	[%]
-0.00002	-0.00005	0.003
0.99996	0.99996	0.000
1.99998	2.0000	0.002
3.0000	3.0001	0.001
4.0000	4.0001	0.001
5.0000	5.0002	0.002
6.0000	6.0001	0.001
7.0000	7.0001	0.001
8.0000	8.0001	0.001
9.0000	9.0002	0.002
9.9999	10.0001	0.002
9.0000	9.0002	0.002
8.0000	8.0002	0.002

Navigation buttons: \leftarrow Back, Next Page, MENU

10.11.2003 15:02

1 Voltage

ET: Low V Low V. Sensor Meas.

HELP

Basic Mode is the focal point of the calibrator's menu structure. Advanced functions are in D/Menu and C/Others.

To measure, generate or simulate, select Quantity and Port from Window 1 Setup or Window 2 Setup menu.

User Guide:
Part B Measuring
Part B Generating/Simulating

Close Lock Keys Basic Mode

Display Area Elements that are Used for Editing Data

There are four different fields/elements that are used for editing data in the display area. Use the B/Field Function Key to move between editable fields in Basic Mode. In configuration windows, use the cursor keys.

Numeric Fields

There are two ways to start editing a numeric field:

Range	0 %	4.0000	mA
	100 %	16.0000	
Range	0 %	4.0000	mA
	100 %	20	

1. Press a numeric key, $\frac{1}{2}$ or \bullet key. Then the entered value replaces the old value.
2. Press the \leftarrow key or the C/Edit Function Key available in some configuration windows. Then you can edit the old value. New digits appear at the end of the old value.

Accept the new value by pressing the \leftarrow key. To discard the edited

value, use the A/Cancel Function Key. See also Part B for special features concerning numeric fields when generating a signal.

Notes.

You cannot add more digits if the length of the number is at its maximum limit. Use the C/←Delete Function Key to remove unwanted digits first and then enter the new digits.

The dual function of the keys: ⓪, ⓑ and Ⓒ is not available in a numeric field. The keys only represent numbers.

Text fields

Press any of the numeric keys or the C/Edit Function Key available in some configuration windows to start editing a text field. Then the menu with the available characters opens for selecting.

Use the numeric keys (1 to 7) to select the character. Use the cursor keys to move the cursor in the text field.

Select the character with the ⓪ or the Ⓒ key. Use the C/←Delete Function Key to remove unwanted characters.

If the character you want to use is not seen in the list of available characters, try the ⓪ or the ⓑ key to see more alternatives.

Accept the new text with the D/Accept Function Key. To discard (cancel) the edited text, use the A/Cancel Function Key.

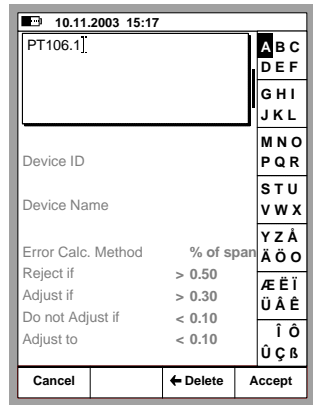





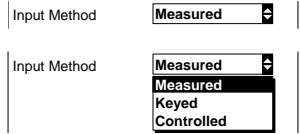

Drop Down Lists

Drop Down Lists are used when there is a limited amount of preset values. You have to select one of the available options. The list of available options is displayed either below or above the Drop Down List field.



A Drop Down List opens when you press the  key or any of the numeric keys or the C/Edit Function Key available in some configuration windows. Small arrows in the upper right and/or lower right corner indicates that the list is longer than the visible part.

Use either the cursor keys  and  or the  and  keys to scroll through the available options. Select one of the options with the  key or the  key.

Pop-up Lists





Pop-up Lists are similar to Drop Down Lists except that Pop-up Lists appear in conjunction with menus. There's a picture of a Pop-up List in chapter **The User Interface** on page 14.



Scrolling a Pop-up List can be done with an additional way (compared Drop Down Lists): Each time you push the numeric menu key that opened the Pop-up List, the cursor advances one step.

Selection Lists

Selection lists are used when you have to choose one of several options. Selection lists are often large, thus almost reserving the whole window.

Selection lists can be longer than the visible part. When the cursor (the row with the inverted text) is on the bottom and you press the  key, the list scrolls and displays more options.

The  and  keys scroll the list one line at a time. The  and  keys to scroll the list one page at a time (if applicable).

Select one of the options with the C/Select Function Key or either the  key or the  key.

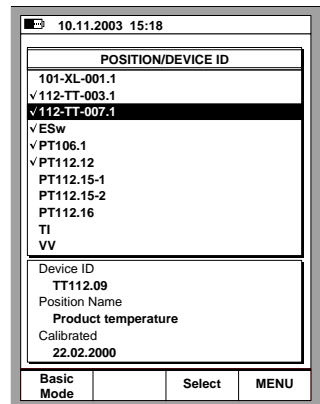

MC5P's Modularity and Options

MC5P includes several optional modules both in hardware and firmware. This makes it possible to buy a calibrator with capabilities according to current requirements. If additional needs arise later on, add more modules to your MC5P and you will have a tool that suits all demands.

Hardware modules/options

MODULE	DESCRIPTION
Base Unit (BU) and...	Required module. Includes the case, display, keyboard, battery pack, common electronics and the ENV, AUX and COMP/PRT connectors as well as a connector for an external pressure module (PX1).
... the Electrical Module (E)	Voltage, low voltage, current and frequency measurement. Also pulse counting, switch testing, HART communication ⁽¹⁾ , current generation, and 24 V loop supply.
Internal Pressure Modules ⁽²⁾ (PM 's)	Modules with positive and compound gauge pressure measurement capability and a barometric module enabling also absolute pressure measurement together with other modules.
External Pressure Module connector (EXT 's)	Connection for external modules capable of measuring high pressures up to 1000 bar (approx. 14500 psi).
Electrical and Temperature Module (ET) and...	Resistance, RTD and thermocouple measurement/simulation. Low voltage measurement/generation. Voltage, current, frequency and pulse generation.
... the Internal Reference Junction Module (RJ)	Internal reference junction compensation for thermocouple measurement/simulation. Cannot be used without the ET Module.

All MC5P's are built around the Base Unit (BU). All other modules are optional, but at least one of the optional hardware modules has to be available in order to measure/generate/simulate a signal.

¹⁾ E module's HART communication requires that the respective firmware option is installed.

²⁾ Max. 9 Internal Pressure Modules.

Other Connectable devices

There is an increasing number of devices that can be connected to MC5P. The following list includes connectable devices that are either already connectable or will be in soon to come firmware updates (valid when this manual was printed):

- External Pressure Modules (EXT)
- Environment temperature sensor (ENV)
- Battery operated portable printer (COMP/PRT)
- Pressure Controllers: POC4, Druck DPI510 and Druck DPI 515 (AUX)
- Temperature Baths/Dry Blocks: Isotech, TekKnow, Ametek/Jofra and HART Scientific (AUX).

Additional information on the battery operated portable printer, pressure controllers and temperature baths/dry blocks is available in part C of this manual.

Firmware options

The standard firmware shipped with MC5P is capable of performing all normal measurement, generation/simulation and calibration tasks. The optional tools give you additional features that enhance MC5P's functionality.

The following firmware options are either already available or will be in soon to come firmware updates (valid when this manual was printed):

- Special temperature sensors
- Communication with QCAL® software
- Drivers for External Devices that are connected to the AUX interface.
- HART communication
- Multichannel datalogging

Safety

The materials of MC5P's case withstand normal industrial conditions.

Internal pressure modules with a measuring range of 6 bar (90 psi) or less are overpressure protected. If the measurement pressure of a pressure module exceeds the module's maximum pressure value, the overpressure protector vents excess pressure inside the MCS100 rack.

Certifications and Compliances (EC Declaration of Conformity)

MC5P Conforms to the EMC directive 89/336/EEC and the Low Voltage Directive 72/23/EEC as attested by conformity with the following harmonized standards:

Product Standard	EN 61326
Safety Requirements	EN 61010-1

Safety Precautions and Warnings

MC5P calibrator is a precision calibration tool that should be used by skilled people. Working with MC5P involves the usage of pressure, temperature and/or electrical instruments. Be sure to know how to work with these instruments and how to safely connect/disconnect pressure hoses as well as electrical test leads clips, etc.

Use MC5P only if you are certain of that it can be used safely. Safe use of MC5P is no longer possible if one or more of the following cases are true:

- When the case of MC5P is evidently damaged
- When MC5P is not functioning as expected
- After prolonged storage in unfavorable conditions
- After serious damage during transport

Sometimes it is necessary to use a portable radio transceiver while working with the calibrator. To prevent calibration errors caused by the radio frequency interference, keep the radio far (at least 1 meter) from the calibrator and the circuit under calibration while sending.

General Warnings

Use only cables provided by Beamex when connecting MC5P to a PC or a printer.

Only use the printer that is available as an option. Using any other printers may damage the printer or MC5P or even both of them.

Also read the MCS100 related warnings found in MCS100 User Guide.

Warnings Concerning the use of Electrical Modules (E and ET)

The measurement and generation terminals of MC5P are protected against over voltage and over current as far as it has been possible without affecting the accuracy. The circuits are designed so, that you can connect a voltage source 50VDC/2A between any terminals without damaging the device. However, long exposure to this kind of stress may affect the accuracy.

Although there is a galvanic isolation between MC5P's ET and E modules, it is for functional purposes only. The max. 50 V restriction applies between these modules too.

Maximum output voltage from MC5P's terminals is below 30 V. If you, however, connect together voltages from the ET and E sections or if you connect external voltages to MC5P, the resulting voltage may be high enough to be hazardous.

General Warnings Concerning Pressure Measurement

The accessory polyurethane hose supplied with an MC5P with pressure modules is rated to the maximum pressure of 20 bar at 21°C (290 psi at 70°F). Applying higher pressure can be hazardous.

To avoid damaging the module, use hand tightening only when connecting the pressure measurement hoses (max. torque 5 Nm, approx. 3.6 lbf ft). If the use of tools is required to secure the connection (typically pressure modules with a pressure range higher than 20 bar), apply the counterforce by placing a 14 mm (approx. 9/16") A/F spanner on the flats found in the module's connector.

Always depressurize the system before opening or connecting any pressure fittings or connectors. Use proper valves for venting the system. Ensure that all connections are made correctly and that the hose and the connectors are intact.

Always use the pressure media stated in the module's sticker. Using unsuitable pressure media may destroy the pressure module.

Never exceed the maximum pressure of a pressure module, be it internal or external. The pressure module's maximum pressure is stated on the module's sticker. The maximum pressure of external modules is also mentioned in the Instruction Leaflet that is provided with the external module.

Never plug a hose with your hands or put the hands in front of a gas spray coming from a leakage. A gas bubble in the blood circulation can cause death.

Warnings Concerning High Pressure

High pressure is always dangerous. Only personnel with good experience and knowledge of high pressure liquid, air and nitrogen operations are allowed to work with the module. Read carefully all these instructions and local safety instructions for high pressure operations before starting the use.

When using gas, the system must not contain any liquid, especially if you do not know how they may react under pressure. Use of clean air or nitrogen is recommended as gaseous pressure media. Liquid pressure media should be preferred when using modules with a pressure range of 60 bar (30000 psi) or more.

If you use nitrogen, minimize the leak to the atmosphere and take care of sufficient ventilation. Close the valve of the nitrogen cylinder, when the system is not in use. Increase in the percentage of nitrogen in the ambient air may cause unconsciousness and death without warning. Read carefully the safety instructions for nitrogen and make sure that the other people in the same space are aware of the danger.

Use of liquid pressure medium is recommended with pressure measurement modules at higher pressure range. Use water or suitable hydraulic oil. Check that the used liquid is not aggressive against the materials used in the transducer or tubing. When using liquid, minimize the amount of air in the system. So you can minimize the amount of spilled liquid in case of leakage.

Do not use the same tubing with different liquids or gases.

Check what the local regulations say about construction and use of pressurized vessels. The regulations normally control construction and use of systems where the product of the pressure and volume exceeds a certain limit. The volume of this system depends on the instrument connected to it.

High pressure gas is dangerous because it can break the container and the flying splinters may cause injury. Also small leaks of gas may be dangerous because the high velocity of the leaking gas jet enables penetration through skin. If a gas bubble gets into the blood circulation, it can cause death. The leak jet is particularly penetrative, if some liquid is coming with the gas.

Service

Only qualified service personnel may perform higher level maintenance for MC5P. **Never open the case unless have explicit instructions from Beamex or a local representative.**

There are, however a few things that anyone using MC5P may do.

Firmware Update

The quickest way to see if a new firmware version is available is checking out Beamex's web site (<http://www.beamex.com>). Go to the "Downloads" page and see what it says about MC5P firmware versions and downloads.

All you need is a Personal Computer and the Computer communication cable that connects MC5P to one of the serial ports in your PC.

Remember to backup all the instrument data in MC5P, using e.g. a calibration management software. Also check for possible release notes accompanying the updated file.

Recalibrating MC5P

Only laboratories approved by Beamex may recalibrate MC5P. Contact Beamex or your local representative for information concerning the recalibration of MC5P. Contact information is on the first pages of this User Guide.

Cleaning MC5P

If MC5P needs cleaning, use cloth soaked with a mild solution of tall oil soap (pine soap). Wait a few minutes and then rinse using a cloth moistened with pure water. Never use any strong detergents.

Cleaning the Contacts of the Internal Reference Junction Module

The contacts of the Internal Reference Junction Block may need cleaning from time to time. The time period varies depending on the environment MC5P is used in.

Carefully open the cover of the Internal Reference Junction Block by using a screwdriver as a wrench. Now you can see the contacts. Remove all impurities and press back the cover. The cover is secured when you hear a click.

(Empty)

Startup and Basic Operation

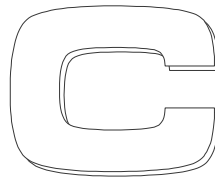
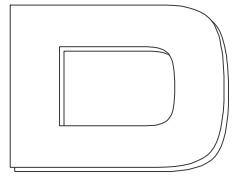

Things discussed in Part B:

- What happens during the startup procedure.
- Measuring signals and doing some special measurements.
- Generating/simulating signals.
- Step and Ramp functions.
- Alarm limits.

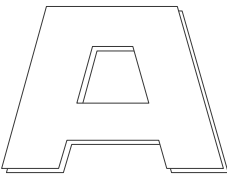

Starting MC5P

Startup Procedure

When MC5P is started, a startup picture appears. After a self test, some basic information of the calibrator at hand appears in the lower part of the screen. If you want to view the calibrator information for a longer period, press the D/Wait function key. Then the calibrator information is visible until you press the D/Continue function key.

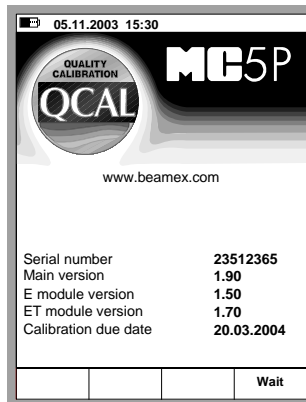

If a module's version number cannot be seen, the module is not included in the MC5P at hand.

The calibration due date that is listed in the startup window is the earliest calibration due date for all connected modules. If the calibrator requires recalibration, MC5P stops at the calibrator information window and the text "Calibrate Soon" appears below the calibration due date row.

Basic Mode, Defined

Every time MC5P is switched on, the startup procedure ends in Basic Mode.

All non-calibration related measurements and generations are performed in the Basic Mode. Briefly: in Basic Mode MC5P works like a high quality multimeter. When returning from MC5P's higher level operations (calibration, viewing of calibration results, calibrator and user configurations), you always return to the Basic Mode.

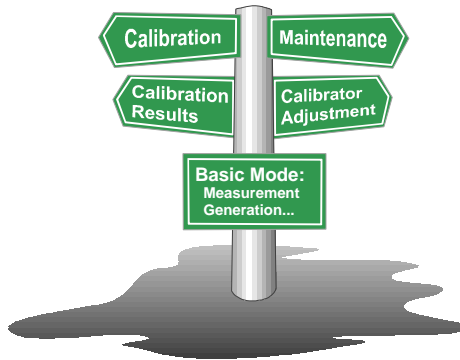

In Basic Mode, the two available measurement/ generation/ simulation windows have default settings based either on factory settings or settings defined when MC5P was previously used.

The first time the D/Menu key is pressed, the Window 1 Setup menu is available. Other possible menus can be selected from the function keys: B/Window 2 Setup and C/Others. The latter function key opens a menu with some special functions and also includes the possibility to go to higher level operations.

Example of a Basic Mode screen with pressure measurement configured in Window 1 and current measurement configured in Window 2:

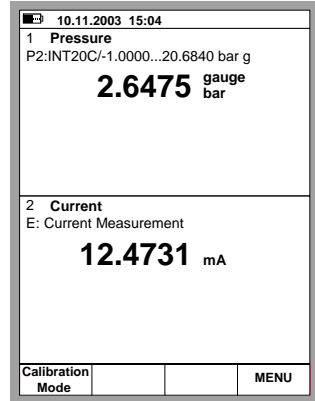

What can be done in Basic Mode

- Measure signals (*)
- Generate signals (*)
- Simulate signals (*)
- Start special measurement (min/max value etc.)
- Perform a Limit Switch Test
- Set alarm limits
- Use the ramping function
- Use the stepping function

*) Available options depend on the installed modules.

Next...

Measuring on page 37

Generating/Simulating on page 54

Special Measurements on page 49

Alarm Limit Settings on page 69

Special Generations on page 65.

Measuring

All measurements in Basic Mode require that you first select the **Window** to be used (Commands: Start with D/Menu and continue either with A/Window 1 Setup or B/Window 2 Setup). Each measurement has its own unique 1/Quantity and 2/Function/Port settings in their window's menu. The other window menu settings, e.g. measuring unit, refine the measurement characteristics.

When presenting measurements in this manual, the first paragraph tells the module (or modules) that is/are required for the measurement. Because of MC5P's modularity you may or may not have the required module. If the module is not included in your MC5P, the 1/**Quantity** and 2/**Function/Port** settings needed for the measurement are not available as choices in the pop-up lists.

Each measurement also has at least one picture with a circle around some of MC5P's terminals, like in the adjacent picture.

The circle indicates active terminals for each 1/**Quantity** and 2/**Function/Port** setting in the window menu.

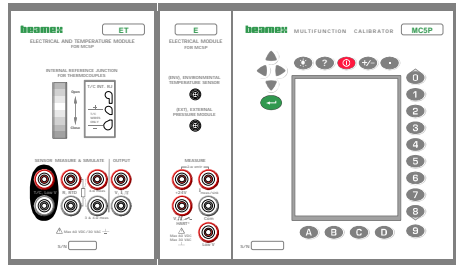

If the picture has more than two terminals circled, then the lighter part is somehow optional. In the following picture, the HART terminal is optional during current measurement.

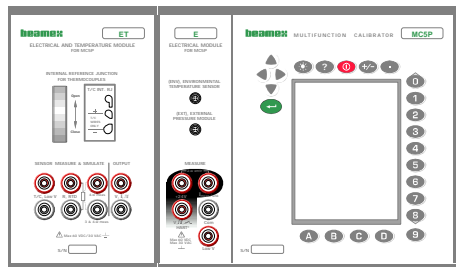

Warning!

Do not apply voltage higher than 50 V (max 2 A) between any terminals.

Pressure Measurement

See chapter **Things to Consider when Measuring Pressure** on page 91 for more information on pressure measurement and internal/external pressure modules.

<u>Required settings</u>	<u>Options/description</u>
Quantity	Pressure
Pressure Type	g gauge pressure or abs absolute pressure.

The available pressure types may be restricted because of the selected pressure port / pressure module. For more information concerning pressure types, see chapter **Pressure Type** on page 91.

Using Internal Modules

Select an internal pressure module port with a suitable measuring range and with an ability to measure the required pressure type:

Port P1: INTxxxx,
P2: INTyyyy
...if applicable, up to:
P9: INTzzzz.

Using External Modules

Select the external pressure module port with a connected pressure module and a suitable measuring range and with an ability to measure the required pressure type, e.g.

Port PX1: EXTxxxx

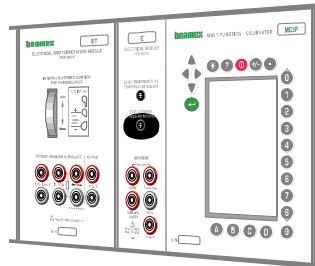
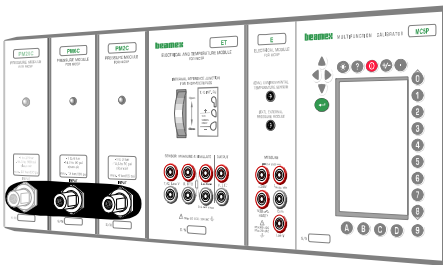

Connecting and Removing External Pressure Modules

An external pressure module may be connected and removed at any time. If a removed module was part of an active measurement, MC5P automatically changes the measurement to a suitable internal pressure module. MC5P also emits a “beep” to inform you of the fact that the external pressure module used for pressure measurement was disconnected.

Configuring a Supply Voltage or Current When Testing a Pressure Sensor

If you are testing a pressure sensor and need a supply Voltage or Current for it, open the appropriate window setup menu (select D/Menu, A/Window 1 Setup or B/Window 2 Setup). Continue to the third submenu by pressing the numerical key **8** twice. The adjacent picture displays all the submenus available when the selected Quantity is Pressure.

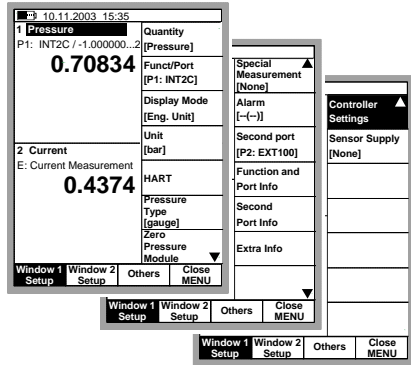

Select 2/Sensor Supply and choose either Current or Voltage supply. A field for entering the supply Voltage/Current value appears in the pressure measurement window.

Zeroing a Pressure Module

If the selected pressure module does not display zero gauge pressure when the applied pressure is zero, the module has to be zeroed.

Open the appropriate window setup menu (D/Menu, A/Window 1 Setup or B/Window 2 Setup) and select menu option 7/Zero Pressure Module. If a secondary pressure module is active in the selected window, a pop-up menu will appear for choosing either to zero the primary or the secondary pressure module.

NOTE!

We recommend that you zero the used pressure module every time before you start measuring pressure with it. When using an external pressure module, zero it every time you change its position.

Next...

- Special Measurements** on page 49
- Alarm Limit Settings** on page 69
- Special Generations** on page 65
- Calibration**, see Part D.

Current Measurement

The current measurement terminals are located in the E module.

Required settings Options/description

Quantity	Current
Func/Port	E: I(meas)

External supply

When the measuring circuit includes an external power supply, use the terminals shown in the picture below.

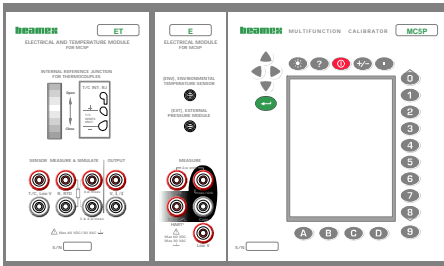

Internal Supply

When you want to use MC5P's 24 V terminal to supply the measuring circuit, use the terminals shown in the picture below.

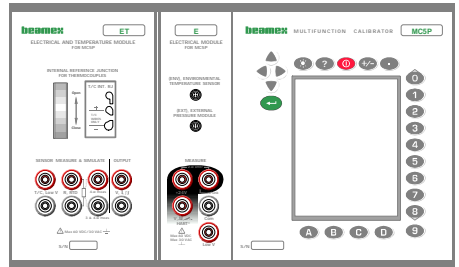

Based on the terminals in use, MC5P automatically acts as either a pure current measuring unit or as a current measuring unit while at the same time supplying the measuring circuit.

Notes.

Check the polarity of your connections. The arrows in the previous pictures describe the correct flow of current.

If you are using a transmitter with HART capability, make also a connection to MC5P's HART terminal. For more information concerning HART connections, see Appendix 1, chapter **Connecting MC5P and a HART Instrument** on page 138. Information concerning current measurement parallel to a test diode can be found in part C, chapter **Current Measurement Parallel to a Test Diode, Connections** on page 99.

Next...

Current Generation on page 56
Special Measurements on page 49.
Alarm Limit Settings on page 69.
Calibration, see Part D.

Voltage Measurement

The E module has terminals for low voltage measurement within the range ± 1 V and terminals for voltage measurement within ± 50 V range. The ET module also has low voltage measurement terminals with a range of ± 500 mV. The ET module terminals are also used when measuring/simulating thermocouples using an external Reference Junction.

Required settings	Options/description
Quantity	Voltage
Funct/Port	ET: LowV(mea), E: LowV(mea) or E: V(meas)

Measuring Low Voltages

Select either Function/port ET: LowV(mea) or E: LowV(mea) and choose a suitable unit. The following pictures display the active terminals for both available ports.

ET: LowV(mea), ± 500 mV:

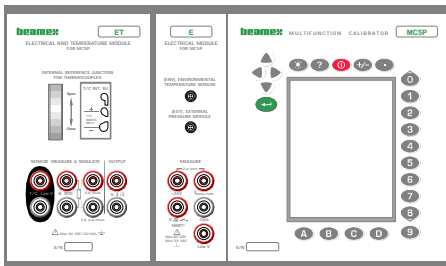

E: LowV(mea), ± 1 V:

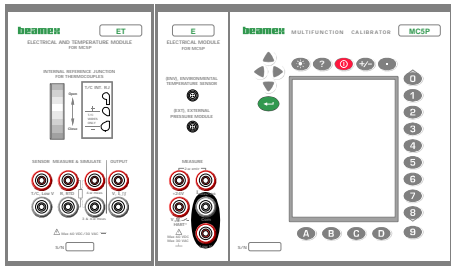

MC5P displays the measured low voltage in the selected window.

Hint!

Low voltage measurement can be used for non-standard thermocouple measurement. You will see the measured temperature in millivolts and need a table to convert the measured millivolt value to corresponding temperature values. In this case, use copper extension cords to connect the non-standard thermocouple to MC5P's terminals.

Measuring Voltages up to ± 50 V

Select Function/port E: V(meas) and choose a suitable unit.

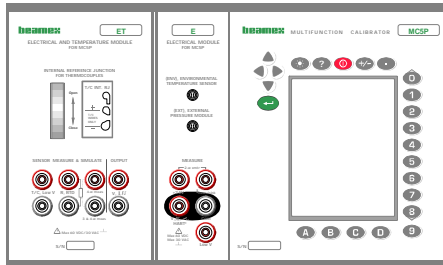

MC5P displays the measured voltage in the selected window.

Warning!

Do not apply voltages higher than 50 V between any of MC5P's terminals.

Next...

Voltage Generation on page 58

Thermocouple Measurement (Temperature) on page 47

Special Measurements on page 49.

Alarm Limit Settings on page 69.

Calibration, see Part D.

Resistance Measurement

Resistance measurement terminals are located in the ET module.

Required settings Options/description

Quantity	Resistance
Funct/Port	ET: R(meas)

The following picture displays the active terminals:

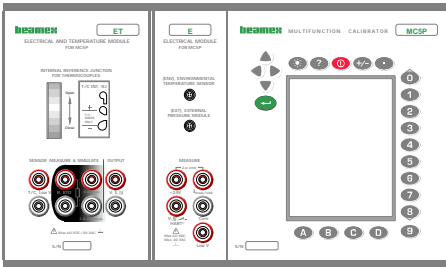

The two leftmost terminals are used in 2-wire systems. MC5P automatically checks the connection and displays the found wiring system (2-wire, 3-wire or 4-wire) in the measuring window. For more information concerning wiring options, see **Resistance and RTD Measurement, Connections** on page 97.

Note.

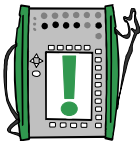

If the measured resistance value is infinite or very high (> 4000 ohm), the text “+OVER” is displayed in the measuring window. This means that the circuit is broken or the connection is wrong. Wrong connection may also cause erroneous reading, typically too low. If necessary, use the 2-wire ohm measurement to check the wiring before final connection.

Next...

- RTD and Resistance Simulation** on page 62
- RTD Measurement (Temperature)** on page 46
- Special Measurements** on page 49.
- Alarm Limit Settings** on page 69.
- Calibration**, see Part D.

Switch State Sensing

The switch state detection terminals are located in the E module.

<u>Required settings</u>	<u>Options/description</u>
Quantity	Switch
Funct/Port	E: Switch (selected automatically when the corresponding Quantity setting is activated)

Also check the Sound setting. The option Change means that MC5P beeps every time the switch changes its state. When using options Open or Closed the sound is **continuously on** when the switch is **open** respectively **closed**.

The contact should be free of external potential. If this is not possible, use DC voltage within the range -10 V to +30 V. MC5P shows voltages above approx. +1.5 V as open contact and voltages below approx. +1.5 V as closed contact.

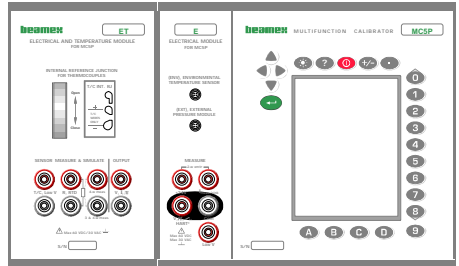

Hint!

Switch state detection may also be used for binary signal detection.

Next...

Limit Switch Test on page 42
Calibration, see Part D.

Limit Switch Test

A limit switch test displays the opening and closing point of a limit switch. MC5P supports limit switch testing of any type of limit switches as long as MC5P is able to either measure or generate/simulate the switch's input signal and is also capable of detecting the switch state.

Notes.

Basic Mode's limit switch test is a restricted version compared to the limit switch test available in Calibration Mode. This test gives you the approximates of the latest opening and closing points and also the current switch status. The limit switch test in Calibration Mode offers more accurate results and additionally, statistical data of repeated switch tests. More of the limit switch test in Calibration Mode in Part D of this manual.

In Basic Mode MC5P does not support limit switch testing when simulating resistance or an RTD sensor. The limit switch test in Calibration Mode also supports resistance and RTD sensor input.

Performing the Limit Switch Test

Configure, e.g. Window 1 to either measure or generate/simulate the switch's input signal (Function keys D/Menu and A/Window 1 Setup in Basic Mode) and Window 2 for switch state detection (Function keys D/Menu and B/Window 2 Setup in Basic Mode). It doesn't matter which window is assigned for which function as long as both the switch's input signal and the switch state are available for MC5P.

Slowly change the switch's input signal and watch how the "Opened @" and "Closed @" data is updated as the switch changes its state.

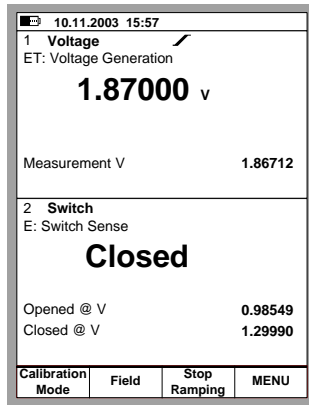

Note.

The accuracy of the “Opened @” and “Closed @” values depend greatly on the change rate of the switch’s input signal.

Hint.

If you use MC5P to generate/simulate the switch’s input signal, you can use ramping to create changing input signals for the switch under test.

Where to find more information when measuring a switch’s input signal...

Pressure Measurement on page 35

Using External Modules on page 35

Voltage Measurement on page 38

Current Measurement on page 37

Thermocouple Measurement (Temperature) on page 47

RTD Measurement (Temperature) on page 46

Where to find more information when generating a switch’s input signal...

Voltage Generation on page 58

Current Generation on page 56

Thermocouple Simulation on page 63

Ramping on page 67

Frequency Measurement

The frequency measurement terminals are located in the E module.

Required settings Options/description

Quantity	Freq.
Funct/Port	E: f(meas)

Also check the Unit setting.

MC5P compares the external potential against an adjustable reference voltage (Trigger Level, range: -1 ... +15 V) when measuring the frequency.

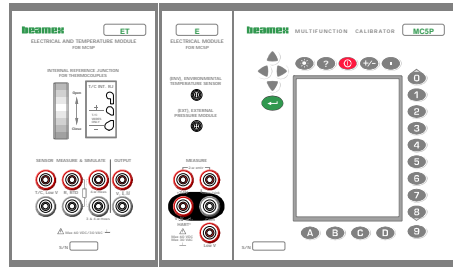

Next...

- Switch State Sensing** on page 41
- Pulse Counting** on page 45
- Frequency Generation** on page 60
- Calibration**, see Part D.

Pulse Counting

The pulse counter terminals are located in the E module.

Required settings Options/description

Quantity	Pulses
Funct/Port	E: Pls(count)

Also check the Trigg.Edge setting.

MC5P compares the external potential against an adjustable reference voltage (Trigger Level, range: -1 ... +15 V) when counting pulses.

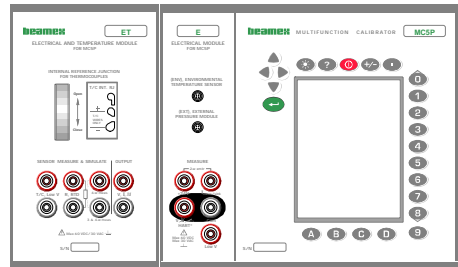

The counter may be cleared (zeroed) by selecting D/Menu, 6/Clear counter.

Next...

Frequency Measurement on page 44

Switch State Sensing on page 41

Pulse Generation on page 61

Calibration, see Part D.

RTD Measurement (Temperature)

RTD-measurement terminals are located in the ET module.

Required settings Options/description

Quantity	RTD-Temp.
Funct/Port	ET: RTD(meas)
Sensor Type	Available RTD sensors

The following picture displays the active terminals:

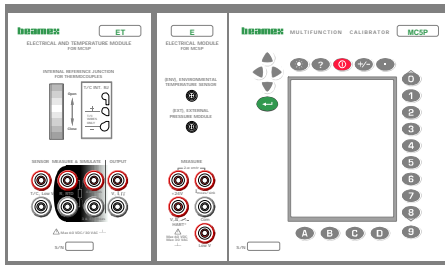

The two leftmost terminals are used in 2-wire systems. MC5P automatically checks the connection and displays the found wiring system (2-wire, 3-wire or 4-wire) in the measuring window. For more information concerning wiring options, see **Resistance and RTD Measurement, Connections** on page 97.

Note.

If the measured resistance value is infinite or very high (> 4000 ohm), the text “+OVER” is displayed in the measuring window. This means that the circuit is broken or the connection is wrong. Wrong connection may also cause erroneous reading, typically too low. If necessary, use the 2-wire ohm measurement to check the wiring before final connection.

Next...

- RTD and Resistance Simulation** on page 62
- Thermocouple Measurement (Temperature)** on page 47
- Resistance Measurement** on page 40
- Special Measurements** on page 49.
- Alarm Limit Settings** on page 69.
- Calibration**, see Part D.

Thermocouple Measurement (Temperature)

Thermocouple measurement terminals are located in the ET module.

<u>Required settings</u>	<u>Options/description</u>
Quantity	T/C-Temp
Funcnt/Port	ET: TCi(mea) (for the internal Reference Junction), or ET: TCx(mea) (for other RJ compensation methods)
Sensor Type	Available thermocouples
Reference Junction	Depends on the Function/Port setting. See subsequent chapters.
Second port	Available only if RTD sensor is not used as the Reference Junction compensation method.

Internal Reference Junction

To use the Internal Reference Junction, select Function/Port ET: TCi(mea). The Reference Junction compensation method Internal is automatically selected.

External Reference Junction

To use an External Reference Junction, select Function/Port ET: TCx(mea) and choose one of the available Reference Junction compensation methods: Entered, 0°C or available RTD sensors.

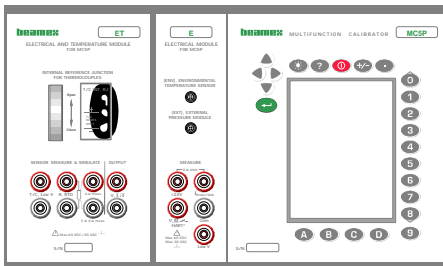

Additional information is found in chapter **Internal Reference Junction** on page 93.

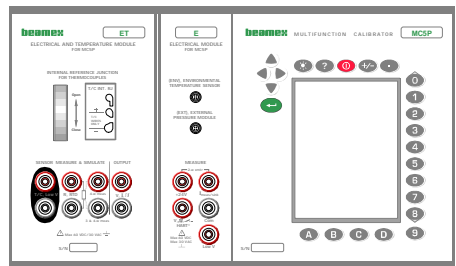

Additional information is found in chapter **External Reference Junction** on page 94.

Note.

MC5P has a comprehensive set of predefined sensor types. Additional sensor types are available as options.

Warning!

If you connect an RTD sensor to the ET module's R, RTD connectors, there is no galvanic isolation between the thermocouple and the RTD sensor.

Next...

Thermocouple Simulation on page 63

RTD Measurement (Temperature) on page 46

Voltage Measurement on page 38

Special Measurements on page 49.

Alarm Limit Settings on page 69.

Calibration, see Part D.

Problems with thermovoltage measurement? See **Error situations** on page 96.

Special Measurements

Special measurements are extra utilities that can be activated to perform a special function alongside the normal measurement.

Only one of the special measurements may be activated at a given time for each window/quantity. Activating another special measurement deactivates the earlier special measurement in the same window (or the earlier special measurement using the same quantity).

All special measurements are started similarly:

- Select D/Menu followed by B/Window 2 Setup if needed.
- As the special measurement setting command is located in the window setup's submenu, select either the numerical key **8** or the cursor key **▽** to open the submenu.
- Then select 1/Special Measurements and the type of special measurement from the provided pop-up list (or deactivate a special measurement by selecting the option "None").

Some of the special measurements do not require any additional information. They start immediately after they are activated. **Rate of Change Measurement, Special Filtering and Resolution, Redundant Measurement** and **Deviation Measurement** do however need some additional information. Therefore when you activate them you will have to enter the required additional information before the special measurement is started.

Notes.

Special measurements are only available in Basic Mode.

If you change any of the main settings of the measurement (Quantity, Funct/Port), the defined special measurement is deactivated.

To zero/restart a special measurement without altering any main measurement settings, do the same menu commands you used for starting the special measurement.

Mathematical Special Measurements

Mathematical special measurements may be assigned to all measurements.

Minimum value

Start the minimum value measurement by selecting:

D/Menu and B/Window 2 Setup, if needed,
 Ⓚ or ▾,
 1/Special Measurements,
 Minimum Reading.

Maximum value

Start the maximum value measurement by selecting:

D/Menu and B/Window 2 Setup, if needed,
 Ⓚ or ▾,
 1/Special Measurements,
 Maximum Reading.

Min/Max value

Start the minimum/maximum value measurement by selecting:

D/Menu and B/Window 2 Setup, if needed,
 Ⓚ or ▾,
 1/Special Measurements,
 Min/Max Readings.

Rate of Change

Start the rate of change measurement by selecting:

D/Menu and B/Window 2 Setup, if needed,
 Ⓚ or ▾,
 1/Special Measurements,
 Rate of Change...

Before the special measurement is started MC5P prompts for the rate of change unit which can be selected from the following options: **1/s**, **1/min** and **1/h**.

10.11.2003 16:00	
RATE OF CHANGE MEASUREMENT	
Quantity	T/C-temperature
Port	ET: TC(meas)
Unit	°C
Rate of Change Unit	1/s
Cancel	Edit Start

Special Filtering and Resolution

Start using special filtering and resolution by selecting:

D/Menu
and B/Window 2 Setup, if
needed,
Ⓚ or ▾,
1/Special Measurements,
Filter and Resolution....

Select the Time Constant setting
and how many decimals should be
cut off from the actual resolution of
the current measurement. The fil-
ter is a 1st order digital filter.

None means “No additional filter-
ing” and “Use the modules own resolu-
tion” respectively.

Note.

You cannot “worsen” the resolution to less than one significant digit.

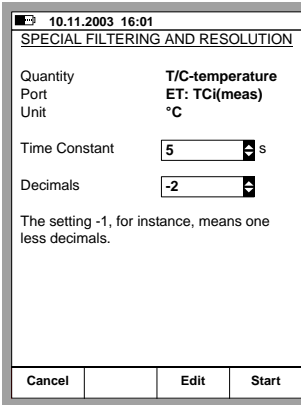

Deviation Measurement

In deviation measurement the read-
ing of the main port is compared to
a reference value. The reference
value is subtracted from the read-
ing of the main port. Start the de-
viation measurement by selecting:

D/Menu
and B/Window 2 Setup, if
needed,
Ⓚ or ▾,
1/Special Measurements,
Deviation Meas....

You can enter the reference value
when you start the special mea-
surement mode.

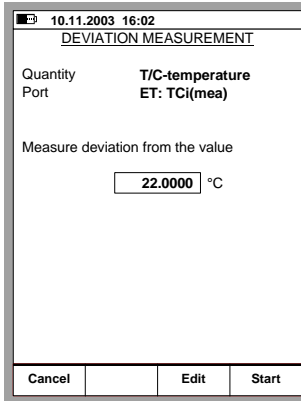

Note.

Keep in mind that when the displayed deviation reading is small
compared to the actual reading, a significant part of the deviation
value may be measurement error. See the specifications for mea-
surement errors at the actual measurement level.

Special Measurements Using Two Ports Simultaneously

The following special measurements only apply when two ports are simultaneously used in the same window. The Second Port setting in the window's setup menu allows you to select another port for the same window. The Second Port setting is enabled depending on selected quantity and available modules.

Difference Measurement

In difference measurement the difference between the reading of the main port and the second port is calculated. The reading of the second port is subtracted from the reading of the main port.

Start the difference measurement by selecting:

D/Menu and B/Window 2 Setup, if needed,

Ⓢ or ▾,

1/Special Measurement,

Difference Meas....

Notes.

Difference measurement is not available as an option in the list of special measurements, unless two measurement ports are activated in the same window.

No setting window appears, but the calculated difference is displayed in the special measurement row.

The measurement value of the second port may be assigned to the Extra Info row at the bottom of the window.

Keep in mind that when the displayed difference reading is small compared to the actual reading, a significant part of the difference value may be measurement error. See the specifications for measurement errors at the actual measurement level.



If the measuring spans of the selected ports are different, make sure you do not exceed the measurement range of either port.

Redundant Measurement

In redundant measurement the measurements of the main port and the second port are compared with each other. If the readings differ more than the entered limit value, MC5P gives an audible alarm.

Start the redundant measurement by selecting:

D/Menu and B/Window 2 Setup, if needed,

 or ,

1/Special Measurement,
Redundant Meas....

You can enter the allowed deviation between the two measurements when you start the special measurement mode.

Notes.

Redundant measurement is not available as an option in the list of special measurements, unless two measurement ports are selected for use in the same window. The measurement value of the second port is displayed on the special measurement row. You may assign the allowed deviation value to be displayed on the Extra info row at the bottom of the window.

When setting the allowed difference, take the accuracies of the measurements into account.

If the measuring spans of the selected ports are different, make sure you do not exceed the measurement range of either port.

10.11.2003 16:03	
REDUNDANT MEASUREMENT	
Main Measurement	
Quantity	Pressure
Port	P1
Second Measurement	
Quantity	Pressure
Port	P2
While displaying the main measurement, compares it to the second and alarms if readings differ more than	
<input type="text" value="0.00100"/> bar	
Cancel	<input type="text"/>
Edit	Start

Generating/Simulating

General

This chapter and the subchapters describe only how to generate/simulate signals using MC5P's own modules. Part C discusses the use of external devices connected to the auxiliary interface.

MC5P is capable to perform the following generation/simulation functions:

- Voltage generation
- Current generation
- Frequency and pulse generation
- Thermocouple simulation
- RTD and resistance simulation

Generation/simulation in Basic Mode require that you first select the **Window** to be used (Commands: Start with D/Menu and continue either with A/Window 1 Setup or B/Window 2 Setup). Each generation/simulation has its own unique 1/Quantity and 2/Function/Port settings in their window's menu. The other window menu settings (generation/simulation unit etc.) refine the generation/simulation characteristics.

The presentation of each generation/simulation begins with a paragraph defining the modules that include terminals required for the generation/simulation (Most generated/simulated signals are done with the ET module but current generation may also be done with the E module). Because of MC5P's modularity you may or may not have the required module. If the module is not included in your MC5P, the 1/**Quantity** and 2/**Function/Port** settings needed for the generation/simulation are not available as choices in the pop-up lists.

Each generation/simulation also has at least one picture with a circle around some of MC5P's terminals, like in the adjacent picture.

The circle indicates active terminals for each 1/**Quantity** and 2/**Function/Port** setting in the window menu.

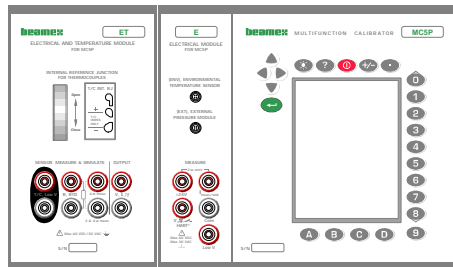

Warnings!

When selecting a generation/simulation function, MC5P always starts with zero output (not when simulating a resistance). This is done to prevent damages in the connected instrument.

Be careful when increasing the generated/simulated signal. If an instrument that cannot withstand the generated signal is connected to MC5P, the instrument may get seriously damaged.

Changing the Value of the Generated/Simulated Signal

Move the field indicator on the display until it surrounds the value of generated/simulated signal (use the B/Field Function Key or the cursor keys).

Enter the new value using the numeric keys. You may cancel the editing by pressing the A/Cancel Function Key. The C/←Delete Function Key removes the rightmost digit.

Accept the new value by pressing either the → key or the D/OK Function Key.

Note.

The dual function of the keys: ①, ② and ③ is not available in a generation field. The keys only represent numbers.

Fine Tuning the Generated/Simulated Signal

Press either of the left or right arrow keys (◀ or ▶) to start the Fine Tuning of the selected numeric field.

Then one of the digits in the number is underlined indicating which digit can be fine tuned. If needed, press the left or right arrow buttons again to select another digit for Fine Tuning.



To change the value of the underlined digit, use the up and down arrow keys (Δ ▽). The changes take effect immediately.

To end Fine Tuning, press either the → key or the D/Close Function Key. The C/Edit Function Key ends Fine Tuning and allows you to enter a number using the numeric keys.

Notes.

You cannot exceed the minimum/maximum limit of the quantity with the Fine Tuning utility.

The fine tuned value follows the resolution properties of the generated/simulated quantity.

Current Generation

MC5P can generate current both with the E and the ET module. Additionally the E module can be used both in source and sink mode.

<u>Required settings</u>	<u>Options/description</u>
Quantity	Current
Funct/Port	ET: I(gen) or E: I(control)

Using the ET module’s output terminals

When generating current from the ET module’s output terminals, select Funct/Port option ET: I(gen). The following picture displays the active terminals:

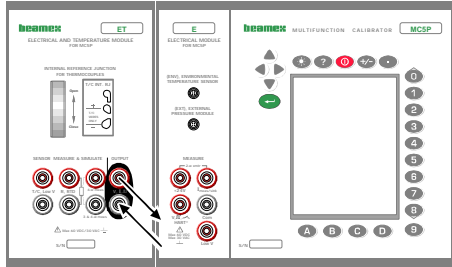

Notes.

If you are simultaneously using the ET module’s output terminals and some of the ET module’s measuring terminals, there is no galvanic isolation between the measuring circuit and the current generation.

The voltage between the output connectors of the ET module is limited to ± 15 Volts. There is no sinking possibility in the ET module.

Using the E module’s output terminals

When generating current from the E module’s output terminals, you can either use MC5P’s internal 24V supply (source mode) or use an external supply and let MC5P control the current (sink mode).

Active terminals in source mode (below):

Active terminals in sink mode (below):

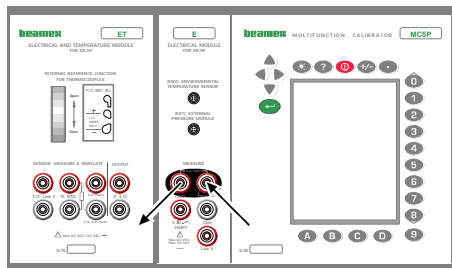

Based on the terminals in use, MC5P automatically selects either source or sink mode.

Note.

The output current of the E module is a “pure” analog signal without any embedded HART signal.

Notes applying to both the ET: I(gen) and the E: I(control) ports:

Check the polarity of your connections. The arrows in the previous pictures describe the correct flow of current.

If the loop resistance of the external circuit is too high or infinite, the message “**O.LOAD**” is displayed until the load is reasonable.

Warnings!

Make sure that you don’t exceed the maximum current allowed by the instrument under test.

If you open the mA generation loop, MC5P tries to maintain the current by increasing the output voltage. If you then close the loop again, the current is first too high, but returns quickly to the correct level. If this current peak could damage the components of the loop, make sure that the loop will not open or protect it against overcurrent. For the same reason, always enter 0 mA output before connecting the loop.

Next...

Current Measurement on page 37

Special Generations on page 65

Calibration, see Part D.

Voltage Generation

The ET module has terminals for voltage generation within ± 12 V range and terminals for low voltage sensor simulation with the range ± 500 mV. The low voltage terminals are also used when measuring/simulating thermocouples using an external Reference Junction.

Required settings	Options/description
Quantity	Voltage
Func/Port	ET: V(gen) or ET: LowV(sim)

Generating Voltages up to ± 12 V

Select Function/port ET: V(gen) and choose a suitable unit.

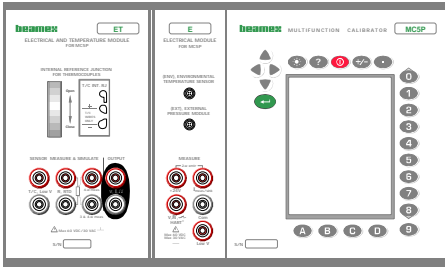

MC5P displays both the set value and the internally measured value for the generated voltage in the selected window. Max. output current depends on the voltage level as follows: 10 mA if the Voltage is within ± 10 V or 3 mA if the Voltage is outside of ± 10 V.

Low Voltage Generation

Select Function/port ET: LowV(sim) and choose a suitable unit. The max. output current is 5 mA.

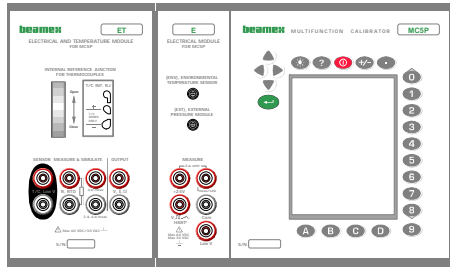

MC5P displays both the set value and the internally measured value for the generated voltage in the selected window.

Note.

If the resistance of the external circuit in voltage generation is very low (obvious short circuit), the message “**O.LOAD**” is displayed until the load is reasonable.

Hint!

Low voltage generation can be used when calibrating instruments with millivolt input. You can use it also to simulate special thermocouples not defined in MC5P. If you simulate a thermocouple in millivolt mode, you must convert from temperature to millivolts manually.

Warning!

If you short circuit the voltage output, MC5P tries to maintain the voltage by increasing the output current. If you then remove the short circuit, the voltage is first too high, but returns quickly to the correct level. If this voltage peak could damage the components of the circuit, make sure that the circuit can not be shorted or protect the circuit against overvoltage. For the same reason, always enter 0 V output before connecting

Next...

Voltage Measurement on page 38
Thermocouple Simulation on page 48
Special Generations on page 65
Calibration, see Part D.

Frequency Generation

The frequency generation terminals are located in the ET module.

Required settings Options/description

Quantity	Freq.
Funct/Port	ET: f(gen)

Also check the Unit and Waveform settings.

MC5P generates sine or square wave with given amplitude and frequency. Minimum allowed frequency is 1 Hz, but the specification is valid for frequencies above 40 Hz only. When generating a square wave, the output DC-level can be set to symmetric or all positive.

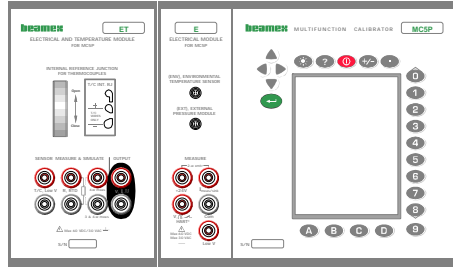

The amplitude (V_{pp}) setting range is: 0.01 V to 12 V.

Next...

Pulse Generation on page 61
Frequency Measurement on page 44
Special Generations on page 65
Calibration, see Part D.

Pulse Generation

The pulse generation terminals are located in the ET module. Pulse generation is similar to square wave frequency output, but it generates a predefined count of all positive or symmetric pulses.

Required settings Options/description

Quantity	Pulses
Funct/Port	ET: Pls(gen)

Also check the Polarity setting.

Enter the amount of pulses MC5P should generate in the pulse generation window. Also enter the **amplitude** and **frequency** to be used.

The pulse generation starts immediately after the amount of pulses value is entered.

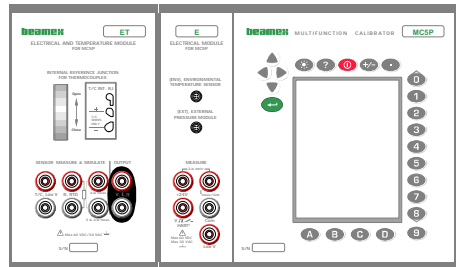

Note.

If you change the frequency after the pulse generation has started, the frequency is adjusted during the current cycle, but the frequency is not correct until the next cycle.

Next...

Frequency Generation on page 60

Pulse Counting on page 45

Special Generations on page 65.

RTD and Resistance Simulation

MC5P mimics the RTD or the resistor to be measured by the instrument under test. The instrument under test generates the current for the resistance measurement. MC5P controls the voltage across its terminals so that the resistance (voltage to current ratio) corresponds to the simulated temperature or resistance. MC5P can simulate resistance between 1 to 4000 ohm.

RTD and resistance simulation terminals are located in the ET module.

<u>Required settings</u>	<u>Options/description</u>
Quantity	RTD-Temp. (for RTD simulation) Resistance (for resistance simulation)
Funct/Port	ET: RTD(sim) (for RTD simulation) ET: R(sim) (for resistance simulation)
Sensor Type	Available RTD sensors. Only needed when doing RTD simulation.

The correct resistance value is between the resistance simulation terminals of the calibrator. Use of 2-, 3- or 4-wire connection is up to the receiver instrument. Use only the two leftmost R, RTD terminals with every wiring option. Connect the possible third and fourth wire according to the requirements of the connected instrument, but use only the two leftmost R, RTD terminals.

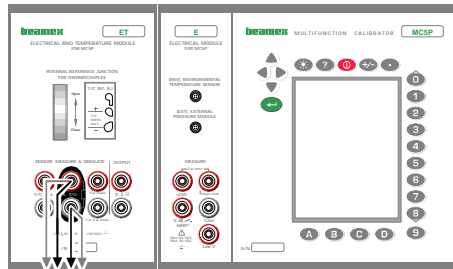

Notes.

In RTD and resistance simulation MC5P monitors the resistance measurement current. If the current is too high, it cannot simulate the right resistance value. In that case it shows the message “H.CURR”. Respectively, if the measurement current is so low that it may affect the accuracy, the message “L.CURR” is displayed.

Accurate operation of the simulation electronics requires that the current supplied by the instrument under test does not vary rapidly. The simulation result is not accurate if the instrument under test uses AC current. If the instrument under test uses pulsed measurement current it should wait a few milliseconds before starting the measurement after setting the current.

Next...

Thermocouple Measurement (Temperature) on page 47
RTD Measurement (Temperature) on page 46
Resistance Measurement on page 40
Special Generations on page 65
Calibration, see Part D.

Thermocouple Simulation

MC5P is able to mimic a thermocouple at given temperatures. This property is called thermocouple simulation. It enables checking and calibration of temperature indicators, recorders, transmitters and other equipment related to temperature measurement with a thermocouple probe.

In thermocouple simulation the original thermocouple is disconnected from the instrument under test and replaced with MC5P. To the instrument under test MC5P appears as a thermocouple at the given temperature.

Thermocouple simulation terminals are located in the ET module.

<u>Required settings</u>	<u>Options/description</u>
Quantity	T/C-Temp
Func/Port	ET: TCi(sim) (for the internal Reference Junction), or ET: TCx(sim) (for other RJ compensation methods)
Sensor Type	Available thermocouple types
Reference Junction	Depends on the Function/Port setting. See subsequent chapters.

Internal Reference Junction

To use the Internal Reference Junction, select Function/Port ET: TCi(sim). The Reference Junction compensation method Internal is automatically selected.

External Reference Junction

To use an External Reference Junction, select Function/Port ET: TCx(sim) and choose one of the available Reference Junction compensation methods: Entered, 0°C or available RTD sensors.

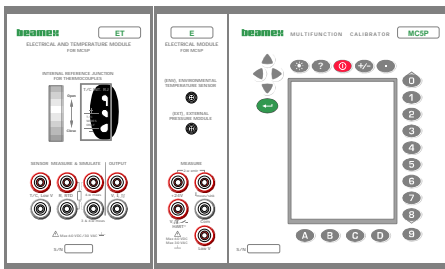

Additional information is found in chapter **Internal Reference Junction** on page 93.

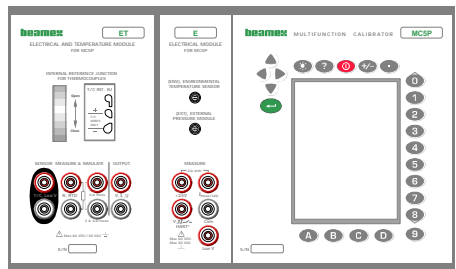

Additional information is found in chapter **External Reference Junction** on page 94.

Notes.

If the resistance of the external circuit in thermocouple simulation is very low (obvious short circuit), the message "**O.LOAD**" is displayed until the load is reasonable.

Check that the instrument under test is set for the same thermocouple type as selected in MC5P. If the type is not one of the available types, you should simulate in millivolt mode and convert from temperature to millivolts manually. More information concerning millivolt generation is in chapter **Voltage Generation** on page 58.

Wire-wound thermocouple temperature indicators and recorders are calibrated with known loop resistance, commonly ten or twenty ohms. The required resistance of the conductors is usually marked on the device. When calibrating such a device, tune the loop resistance to the nominal value with an additional resistor.

Use MC5P's 2-wire resistance measurement to tune the loop resistance of a wire wound device. Short circuit the measuring device for the time of resistance measurement. The resistance measurement may damage the device, if you do not install the short circuit. For more information on resistance measurement, see chapter **Resistance Measurement** on page 40.

Warning!

If you short circuit the thermocouple simulation output, MC5P tries to maintain the voltage by increasing the output current. If you then open the output again, the voltage is first too high, but returns quickly to the correct level. If this voltage peak could damage the components of the circuit, make sure that the circuit can not be shorted or protect the circuit against overvoltage. For the same reason, always enter 0°C output before connecting the circuit.

If you connect an RTD sensor to the ET module's R, RTD connectors, there is no galvanic isolation between the thermocouple and the RTD sensor.

Next...

Thermocouple Measurement (Temperature) on page 47
RTD and Resistance Simulation on page 62
Special Generations on page 65
Calibration, see Part D.

Problems with thermovoltage simulation? See **Error situations** on page 96.

Special Generations

Manual change of generated signals is sometimes a restriction. Therefore MC5P includes **Stepping** and **Ramping** as standard utilities for creating automatically alternating output signals (special generations).

To be able to start the definition of a special generation, a suitable generation/simulation field has to be active in the Basic Mode Window. If a generation/simulation is not started, select D/Menu and either A/Window 1 Setup or B/Window 2 Setup to configure a generation/simulation. For more information on how to configure a generation/simulation, see chapter **Generating/Simulating** on page 54 and its subchapters.

Notes.

Only one of the special generations may be active at a given time. Special generations are available only in Basic Mode.

Opening the Step or Ramp Configuration Window

Open the window setup menu for the generation/simulation quantity that you want to configure a Stepping function for. The menu commands are:

- D/Menu
- and B/Window 2 Setup, if needed,
- Press the numeric key **8** to open the second menu page
- Choose 3/Step, Ramp and
- Either 1/Step or 2/Ramp in the next menu.

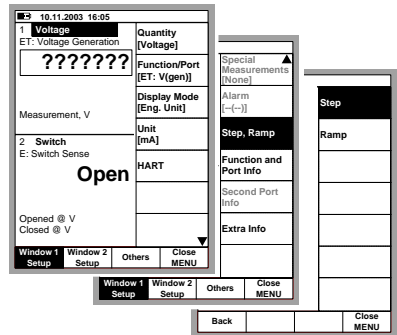

Stepping

The Stepping configuration windows shown below are opened as described in chapter **Opening the Step or Ramp Configuration Window** on page 65.

Configure the Stepping settings according to your needs. The following pictures are examples of stepping configurations. The graph below the configuration window displays the result of the settings.

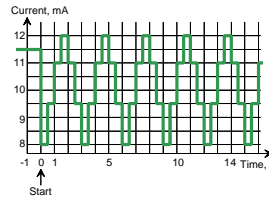
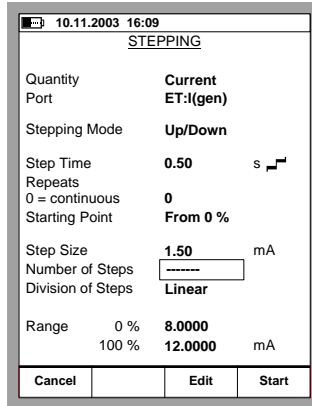
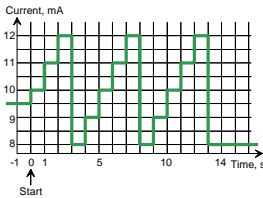
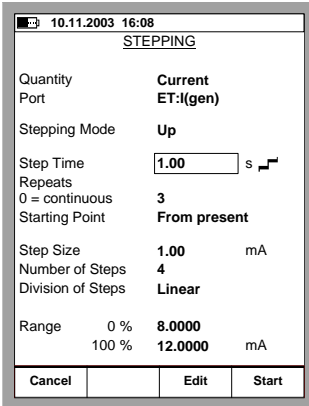

Note that because of the Starting point setting, the first repeat of the leftmost example is limited to a small starting step and only two full steps. Generally: if the stepping settings limit the first repeat to only a fraction of a full repeat it is still calculated as one repeat.

You may enter either the Step Size or the Number of Steps. Because these values depend on each other, the value of the other field is calculated whenever you make any changes. Also, you can only enter an integer as the Number of Steps value. If you

enter a step size that results in a non-integer value for the Number of Steps field, MC5P displays a dashed line instead of a value for the Number of Steps field. This indicates that the size of the step that reaches the 100 % range limit is smaller than the defined step size. See the rightmost example.

To stop stepping press the function key C/Stop Stepping. This applies for both a continuous stepping (Repeats field set to zero) and a stepping with a predetermined amount of repeats (max. value 65535).

Warning!

Do not configure the range settings so that they exceed the allowed input range of the connected instrument. MC5P determines the limits of the range settings based on the selected quantity and port, not the connected instrument.

Ramping

The Ramping configuration windows shown below can be opened as described in chapter **Opening the Step or Ramp Configuration Window** on page 65.

Configure the ramping settings according to your needs. The following pictures are examples of ramping configurations. The graphs presented after the configuration windows display the result of the settings.

10.11.2003 16:10		
RAMPING		
Quantity	Current	
Port	ET:l(gen)	
Wait in 0%	2	s <input type="checkbox"/>
Rise Time	1	s <input checked="" type="checkbox"/>
Wait in 100%	1	s <input checked="" type="checkbox"/>
Fall Time	2	s <input checked="" type="checkbox"/>
Repeats		
0=continuous	<input type="text" value="2"/>	
Range	0 % 8.0000	
	100 % 16.0000	mA
Cancel	Edit	Start

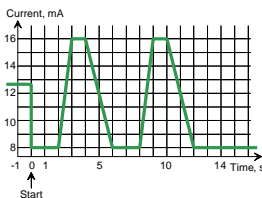

10.11.2003 16:11		
RAMPING		
Quantity	Current	
Port	ET:l(gen)	
Wait in 0%	0	s <input type="checkbox"/>
Rise Time	<input type="text" value="5"/>	s <input checked="" type="checkbox"/>
Wait in 100%	0	s <input checked="" type="checkbox"/>
Fall Time	0	s <input checked="" type="checkbox"/>
Repeats		
0=continuous	0	
Range	0 % 8.0000	
	100 % 16.0000	mA
Cancel	Edit	Start

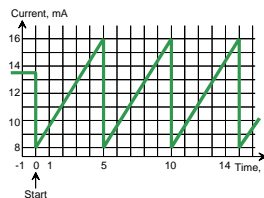

To stop ramping press the function key C/Stop Ramping. This applies for both a continuous ramping (Repeats field set to

zero) and a ramping with a predetermined amount of repeats (max. value 65535).

Note.

MC5P actually makes the ramp in small steps. The steps are as small as possible, slower ramps use smaller steps.

Warning!

Do not configure the range settings so that they exceed the allowed input range of the connected instrument. MC5P determines the limits of the range settings based on the selected quantity and port, not the connected instrument.

Alarm Limit Settings

Each main measurement in a window may have alarm limits settings. MC5P supports “higher than”, “lower than”, “high rate” and “low rate” alarms.

To set the alarm limits, open the window settings menu of the window where the measurement is active (starting from the Basic Mode: D/Menu followed by A/Window 1 Setup or B/Window 2 Setup if needed). As the alarm setting command is located in the window setup’s submenu, select the numerical key 8 to open the submenu.

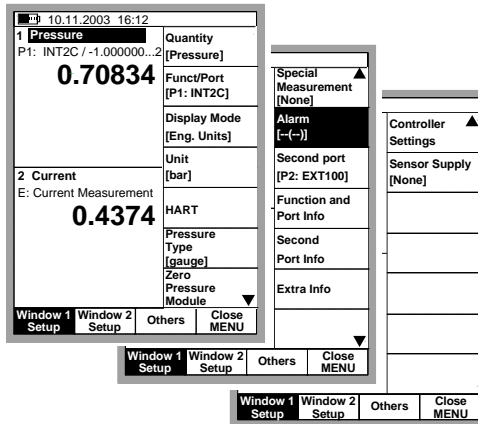

Open the alarm setting window by selecting 2/Alarm.

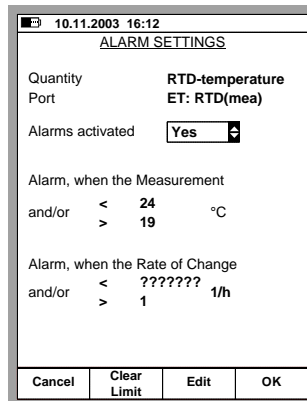

The Alarms activated field makes it possible to deactivate the alarm limits without clearing the limits.

Set the limits as required. Individual alarm limits may be disabled by clearing the alarm limits using the B/Clear Limit Function Key. The “<” (lower than) limit may have a higher value than the “>” (higher than) limit. In that case MC5P emits an alarm when the measurement is inside the range specified by the alarm limits.

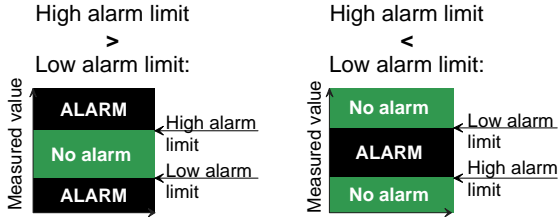

Note.

Remember to set/check also the rate alarm unit if you set any rate alarms.

Appearance of the alarm settings.

The alarm settings can be seen as symbols in the measuring window and in the window setup menu as follows:

<u>Symbol</u>	<u>Definition</u>
[- - (- -)]	No limit settings
[< - (- -)]	Low limit is set
[- > (- -)]	High limit is set
[< > (- -)]	Low and high limits are set
[> < (- -)]	Low and high limits are set. Low > High
[- - (< -)]	Low rate limit is set
[- - (- >)]	High rate limit is set
[- - (< >)]	Low and high rate limits are set
[- - (> <)]	Low and high rate limits are set. Low > High
[< > (< >)]	All limits are set.

Acknowledging alarms

When an alarm limit is exceeded, MC5P emits an audible alarm. The alarm can be acknowledged from all other keys except the following keys: , and or any key combinations including one or more of the previously listed keys. The active alarm limit is underlined in the measurement window as long as the alarm limit is exceeded.

Advanced Operation and Configurations

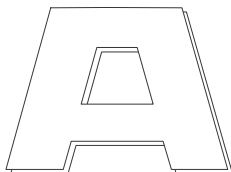
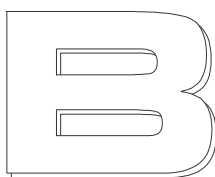
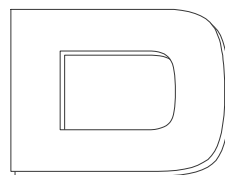

Things discussed in Part C:

- How to configure MC5P to suit your requirements.
- Advanced Utilities available in Basic Mode.
- Additional information: Useful during pressure measurement, thermocouple measurement/simulation and resistance/RTD measurement/simulation.

Configuring the Calibrator

A group of settings are available in MC5P's Others menu's Maintenance option. The following chapters tell how you can change them and what the default settings are.

Settings

The settings window has two pages. To open the settings window starting from Basic Mode, press D/Menu, C/Others and 1/Settings. The leftmost picture is the settings page that opens first.

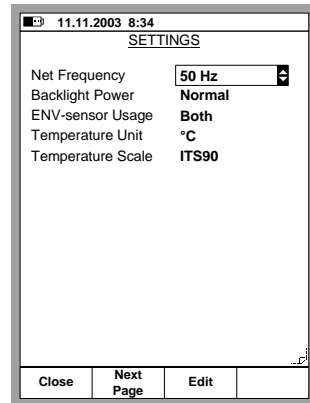
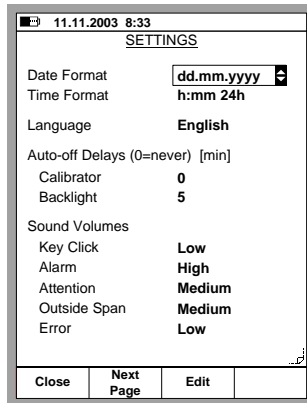

You can scroll between the pages using the B/Next Page Function Key.

Note.

All changes in settings become valid immediately.

Date Format

A drop down list of available date formats: dd.mm.yyyy, yyyy.mm.dd and mm.dd.yyyy.

The default format is “dd.mm.yyyy”.

Time Format

A drop down list of available time formats.

24 hour format: h:mm

12 hour format: h:mm am/pm.

The default setting is the 24 hour format.

Language

A drop down list of available User Interface languages. The default language is English.

Auto-Off Delay for the Calibrator

Wait time before auto power off is executed.

The default setting is “0” (never).

Auto-Off Delay for the Display Backlight

Wait time before the display light is automatically switched off.

The default setting is “5 min”.

Setting the time to zero disables display backlight auto-off.

Volume Settings

MC5P has individual volume settings for the following sounds:

<u>Sound</u>	<u>Default value</u>
*Key Click	Medium
*Alarm	Medium
*Attention	Medium
Outside Span	Medium
Error	Medium

All settings have three different possible values (Low, Medium, High). The ones starting with an asterisk (*) may also be set to “Off”.

Line Frequency

Select the setting that suits the local line frequency (50 or 60 Hz).

Note that wrong line frequency setting affects the accuracy of MC5P.

The default setting is “50 Hz”.

Display Backlight Power

Select the backlight power from the available options:

- Economy
- Normal
- Efficient

The default setting is “Economy”.

ENV Sensor Usage

How the Environment Sensor (ENV) should be used during calibration. Select one of the available options:

- Not Used
- Environment
- Instrument
- Both

The default setting is “Both”.

Temperature Unit

Select either °C (Centigrade) or °F (Fahrenheit) as the temperature unit.

The default setting is “°C”.

Temperature Scale

MC5P supports the use of both international temperature scales: **ITS90** and the older **IPTS68**. Select which one of them is in use.

The default setting is “ITS90”.

Setting Time and Date

To change the time and date (starting from Basic Mode), press D/Menu, C/Others, 2/Maintenance and 2/Time/Date.

11.11.2003 8:35			
TIME/DATE SETTINGS			
Date (dd.mm.yyyy)	13	06	2002
Time (hh:mm:ss)	16	02	22
Cancel		Edit	Accept

Notes.

The date must always be given in **dd.mm.yyyy** format no matter what the configured date format is.

The time must always be given in the **24 hour** format no matter what the configured time format is.

The date and time will be updated when you press the D/Accept Function Key.

Advanced Utilities

All the subsequent chapters:

Measuring the Environment Temperature with the ENV Sensor on page 75,

Display Mode Settings on page 76,

Transmitter/Switch Simulation on page 79,

Data Logging on page 82,

Generating Signals Using External Devices on page 85 and
Printing on page 89

describe the use of additional features that are available in MC5P. Some of the utilities are firmware options and/or they require some additional hardware before they can be utilized.

Measuring the Environment Temperature with the ENV Sensor

The ENV-sensor is a optional environment temperature probe that can be connected to the ENV sensor interface on the left side of MC5P.

Required settings

Quantity
Funct/Port

Options/description

ENV-Temp.
T-ENV(mea) (selected automatically when the corresponding Quantity setting is activated)

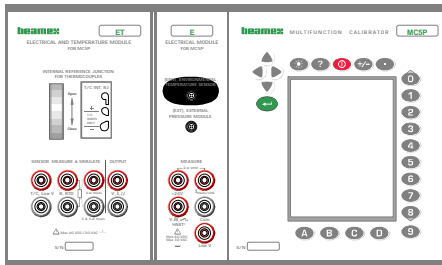

Note!

The ENV-sensor is not accurate enough to be used as a reference sensor. Use it as a tool for obtaining the environment temperature during calibration or as a temperature measurement tool when the accuracy of the measurement is not critical.

Display Mode Settings

By default, MC5P displays all measurement, generation and simulation data in engineering units. In Basic Mode you can also select some special Display Modes. To change the Display Mode, select the Window setup menu (Commands: D/Menu and B/Window 2 Setup, if needed) and choose 3/Display Mode. All of the available special Display Modes are described in the subsequent chapters.

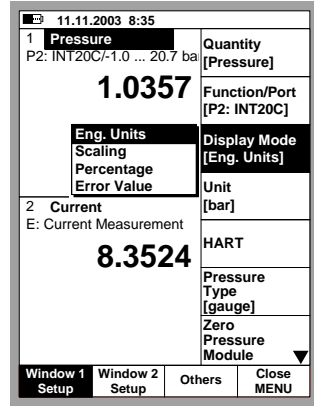

Note.

All special Display Modes are reset to Engineering Units Display Mode if the quantity or port of the window(s) assigned to the special Display Mode are changed.

Warning!

Be careful not to mistakenly read a value shown in special Display Mode as a value shown in Engineering Units. MC5P always displays the true measurement in the window's lower-most row (Extra Info row) when a special Display Mode is active.

Scaling

In scaling, the measured/generated/simulated value is displayed in another, user defined quantity/unit. Start scaling as described in chapter **Display Mode Settings** on page 76.

When selecting Scaling Display Mode, the following configuration window appears:

11.11.2003 8:36	
SCALING	
Quantity	Pressure
Port	P1:INT2C
Measured Range	
0 %	0.000 kPa
100 %	100.000 kPa
Scaled Mode	Current
Scaled Unit	mA
Scaled Range	
0 %	4.000
100 %	20.000
Transfer Function	Linear
Cancel	Edit
Start	

11.11.2003 8:37	
SCALING	
Quantity	Pressure
Port	P1:INT2C
Measured Range	
0 %	0.000 kPa
100 %	100.000 kPa
Scaled Mode	Custom Units
Scaled Unit	Gallons/min
Scaled Range	
0 %	1.00
100 %	5.00
Decimals	3
Transfer Function	Linear
Cancel	Edit
Start	

You can scale the quantity either to a quantity that already exists in MC5P or select Custom Units from the Scale Mode field. Then you can manually enter any unit to the Scale Unit field (see the rightmost picture above).

When scaling is active in a Basic Mode window, the window contains the text "SCALED". The true value is displayed in Extra Info row. If the Extra Info row was assigned to some other measurement before scaling was started, the other measurement is automatically stopped.

Note.

Remember to set the amount of decimals to be displayed for a Custom Unit. The default value is 3.

11.11.2003 8:37	
1	Pressure
P2: INT20C/-1.0 ... 20.7 bar g	
	20.088 SCALED
	Gallons/min
Measurement bar	1.004
2	Current
E: Current Measurement	
	8.3217 mA
Calibration Mode	MENU

Displaying Values in Percentage

In Percentage Display Mode the measured/generated/simulated values are displayed as percentage of a user defined range. Start the Percentage Display Mode as described in chapter **Display Mode Settings** on page 76 and enter the Measured Range. The true value is displayed in the Extra Info row.

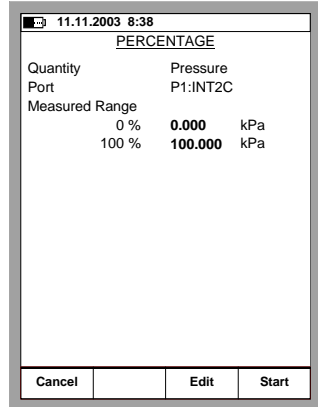

Displaying Error Values

The Error Display Mode utilizes both of Basic Mode's windows. The measured/generated/simulated values of both windows are treated as percentages of user defined ranges. The input value is considered as the "correct" value and the output value should follow the input value, while taking the Transfer Function into account. The window from which Error Display Mode is invoked is considered as the instrument's output signal and the other window as the input signal.

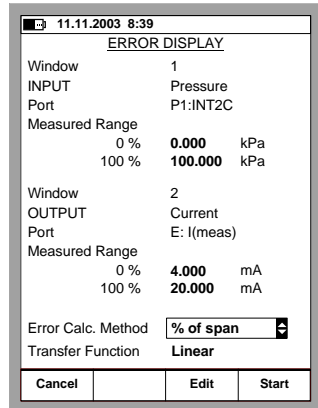

Start the Error Display Mode as described in chapter **Display Mode Settings** on page 76. Enter the Measured Range for both the input and the output signal, the Error Calculation Method and the Transfer Function (input/output correlation).

The true output value is displayed in the Extra Info row.

Note.

The Error Display Mode is only available for a Basic Mode window set for **measuring** a quantity.

Transmitter/Switch Simulation

MC5P's Basic Mode includes a possibility to simulate a transmitter and a switch. To start a Transmitter or as Switch simulation, configure Window 1 to measure a signal (transmitter input) and Window 2 to either generate or simulate a signal (transmitter output), then select D/Menu, C/Others and 6/Transmitter/Switch Simulation. A pop-up list appears where you can select whether you want to simulate a transmitter or a switch.

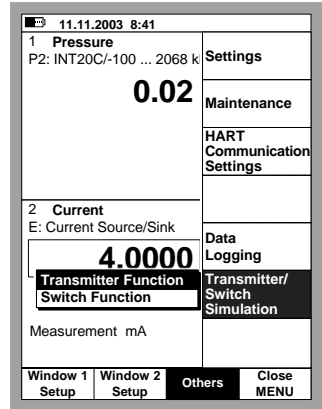

Note.

To be able to start the Transmitter/Switch Simulation, both Basic Mode windows need to be configured accordingly. If, e.g. window 2 is not assigned for generating/simulating a signal, MC5P can not start transmitter simulation.

Transmitter Simulation

Start the Transmitter Simulation as described in chapter **Transmitter/Switch Simulation** on page 79. If the settings of the Basic Mode windows suit Transmitter Simulation, a configuration window similar to the lower left picture is shown.

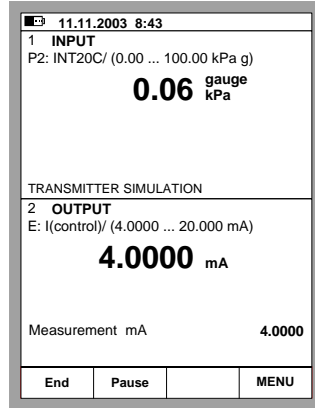
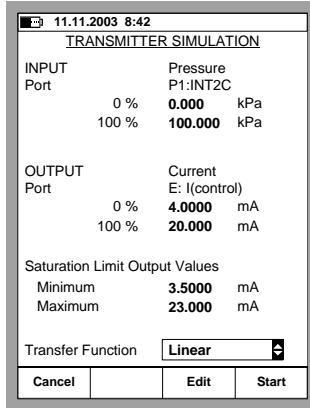

Enter the input and output spans, the saturation limits and also the transfer function.

If the saturation limits differ from the range limits, MC5P extrapolates the output value based on the input value and the Transfer Function until the saturation limit is reached. Then if the input signal drifts farther from the input range, the output value stays at the saturation limit.

The upper right picture shows the Basic Mode window while Transmitter Simulation is active. The second row of both windows display the active port and the input/output range of the simulated transmitter.

Notes.

To Zero a pressure module during Transmitter Simulation, Press D/MENU and 7/Zero Pressure Module.

When pausing the Transmitter Simulation, you can change the generation/simulation signal as in Basic Mode.

Warning!

Remember to scale the output signal of the Transmitter Simulation so that the instrument connected to the output signal loop is not damaged.

Switch Simulation

Start the Switch Simulation as described in chapter **Transmitter/ Switch Simulation** on page 79. If the settings of the Basic Mode windows suit Switch Simulation, a configuration window similar to the lower left picture is shown.

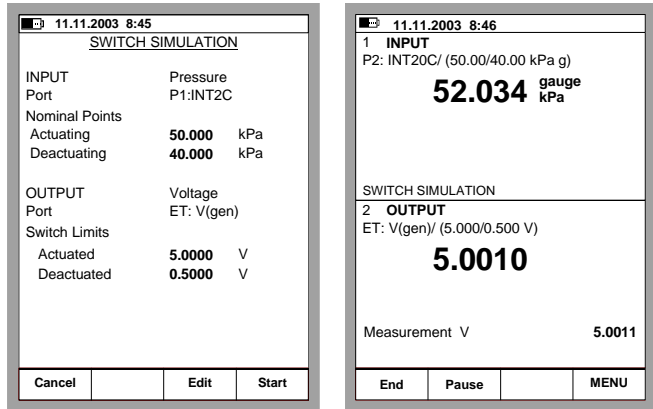

Enter the actuating point and the deactuating point of the input signal. Also enter the output signal levels for an actuated output and a deactuated output.

The upper right picture shows the Basic Mode window while Switch Simulation is active. The second row of the upper window displays the active port and the actuating and deactuating points. The second row of the lower window displays the actuated and deactuated output of the switch.

Note.

To Zero a pressure module during Switch Simulation, Press D/MENU and 7/Zero Pressure Module.

Warning!

Remember to scale the output signal of the Switch Simulation so that the instrument connected to the output signal loop is not damaged.

Data Logging

General

The Data Logging utility is a firmware option that allows you to collect data using MC5P. The collected data may then be viewed, transferred to a personal computer (PC) and printed using a utility shipped together with MC5P if the Data Logging option is purchased.

The maximum amount of measuring channels can be up to seven (valid only if your MC5P includes a sufficient amount of measuring modules/ports).

Data Logging may be configured to collect data using different triggers and saving methods as described further on.

Configuring

To start configuring the Data Logging (starting from Basic Mode), press

- D/Menu,
- C/Others,
- 5/Data Logging.

The upper part of the Data Logging configuration window is reserved for seven measurement channels and the lower part for general settings. The following subchapters describe how they are configured.

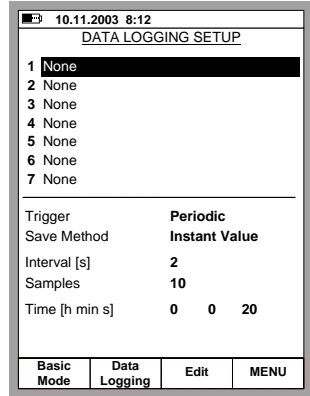

Assigning Measurement Ports to Channels

Move the cursor to one of the measurement channel rows in the Data Logging configuration window. Press C/Edit to open the following channel settings window: Select the measurement port first. The other settings depend on the port setting. To clear a channel, select port None in the channel settings window. To remove all channel settings, select D/MENU, 1/Clear All Channels in the Data Logging configuration window.

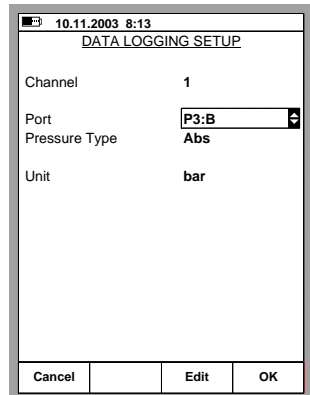

General Data Logging Settings

Trigger Available options: **Periodic**, **Keyboard** and **Clock Start**. When **Keyboard** is selected, the fields **Interval**, **Samples** and **Time** are not needed and thus not shown. When **Clock Start** is selected, a separate field for entering the start time is shown. Enter the time in 24 hour format. Save Method Options: **Instant**, **Average**, **Minimum**, **Maximum**, **Min & Max** and **All values**.

Trigger	Periodic
Save Method	Instant Value
Interval [s]	60
Samples	720
Time [h min s]	12 0 0

Interval

Accepted values: 1 to 3600 seconds. Enter the value as an integer.

Samples

Maximum amount of samples: 70000.

Time

Automatically calculated based on the **Interval** and **Samples** settings. Alternatively, by changing the **Time** settings, the **Samples** value is automatically changed to suit the new **Time** settings.

Note.

In addition to the previously mentioned limits, the maximum values of **Samples** and **Time** settings also depend on the available free memory. If you enter values that require more memory than is available, MC5P automatically replaces the entered value with the currently allowed maximum value.

When a data log is done, you can enter a name for the results.

Starting the Data Log

To start logging, select B/Data Logging in the Data Logging configuration window. Start the Logging by selecting C/Start Logging in the Logging window.

Count	647	38802 s
← Back	Stop Logging	MENU

If the **Trigger** setting is **Periodic**, you can follow how the logging advances in the lower part of the window. Both the amount of samples to be logged and the remaining time is displayed.

If the **Trigger** setting is **Keyboard**, accept the values by pressing the Function Key B/Accept Readings. .

Now the lower part of the window displays the amount samples already logged and the time since the logging was started

To stop/interrupt the logging, be it periodically triggered or triggered from the keyboard, select C/Stop Logging.

Viewing the Results

Opening the Log Results window can be done both from the Configuration window and the Logging window. Select D/MENU 2/View Datalog Results. If you have logged using more than two channels, use the ◀ and ▶ cursor keys to scroll through all the columns. Alternatively: use the numeric keys to quickly jump to a column.

To see the minimum, maximum and average values of the log see the next result page by selecting B/Next Page.

The screenshot shows a window titled "20.11.2003 16:22" with the subtitle "Just Testing - All values". It contains a table with three columns: "Time", "1: Instant Pressure [bar]", and "1: Average Pressure [bar]". The data rows show a sequence of time stamps from 8:19:38 to 8:32:38 with corresponding pressure values. At the bottom, there are navigation buttons: "Back", "Next page", and "MENU".

Time	1: Instant Pressure [bar]	1: Average Pressure [bar]
10.11.2003 8:19:38		
8:20:38	1.0113	1.0113
8:21:38	1.0113	1.0113
8:22:38	1.0112	1.0113
8:23:38	1.0112	1.0112
8:24:38	1.0112	1.0112
8:25:38	1.0111	1.0112
8:26:38	1.0111	1.0111
8:27:38	1.0111	1.0111
8:28:38	1.0111	1.0111
8:29:38	1.0110	1.0111
8:30:38	1.0110	1.0110
8:31:38	1.0110	1.0110
8:32:38	1.0109	1.0109

Removing Datalog results

To remove a set of data logging results, select D/MENU 3/Remove Datalog Data.

To remove all datalog results, select D/MENU 4/Remove All Datalog Data.

Transferring the Results to a Personal Computer

A 32-bit Windows® software called **MC5_Datalog.exe** is shipped together with MC5P if you bought the Data Logging option. Start this software just as any other Windows® software.

All communication between the PC and MC5P is initiated from **MC5_Datalog.exe**. More information of the software in Appendix 3.

Generating Signals Using External Devices

To be able to utilize devices connected to the auxiliary instrument interface (AUX) you need to have the required firmware option. The following paragraph explains how to activate MC5P to use a connected external device. The instructions are also valid when the connected device is changed.

To select an external device, open either Window 1 or Window 2 setup menu (select D/Menu and either A/Window 1 Setup or B/Window 2 Setup in Basic Mode). Make sure the quantity setting of the window corresponds to the external device's quantity requirements. Continue to the third submenu by pressing the numerical key ⑧ twice. The following picture displays all the submenus available when the selected Quantity is Pressure.

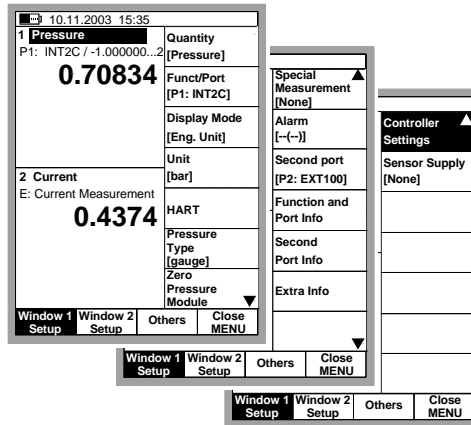

To be able to communicate with the external device, MC5P requires some additional data which you can enter in the window that opens automatically after you have selected the Controller Settings menu option. This is presented on the next page.

Select the Controller Type. The list of available controllers varies depending on installed options and the selected quantity. The other settings vary depending on the Controller Type setting.

Note.

The Settings window for external devices may also be opened from Calibration Mode's Instrument window. Additional information on how to use external devices in Calibration Mode is in Part D chapter **Using External Devices in Calibration Mode** on page 124.

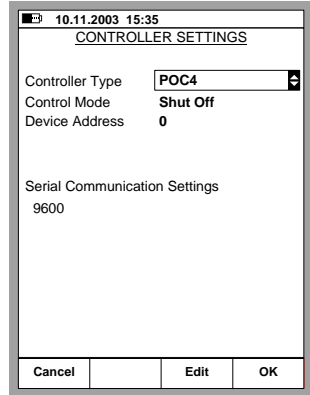

Controlling the External Device in Basic Mode

When an external device is configured for use, the device name is displayed in the window it was assigned to, e.g. POC4 in the adjacent picture. Enter target values (setpoints) for the connected external device in the numerical field following the device name.

Note.

If a field indicator cannot be moved to the external device's setpoint field (or the field indicator is not seen at all), make sure the connections and the settings are in order. When MC5P is able to communicate with the connected device, a communication symbol is shown in the status bar's rightmost end (see picture above).

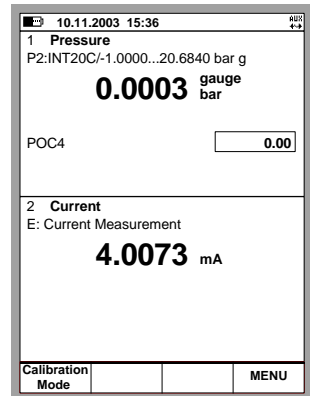

Pressure Controller Settings

The following pressure controllers were supported when this User Guide was written:

- Beamex POC4 and
- Druck DPI510 equipped with the RS232 communication option (only gauge pressure type models).
- Druck DPI 515

The following settings apply in general to all supported pressure controllers. If certain controllers have device specific data, it is mentioned in the general description.

Control Mode

Possible settings: Shut Off and Continuous.

Shut Off means that the Pressure Controller shuts down after the desired pressure level is reached. When Continuous is selected, the Pressure Controller is active all the time. Even after the setpoint value is reached.

The first method is to be preferred because it minimizes the amount of disturbances in the system, provided there are no notable pressure leaks in the system.

Device Address

Device address is needed if the Pressure Controller is in addressed mode. Addressed mode also allows daisy-chain connecting several Pressure Controllers.

Serial communication settings

The communication settings shown in the window are the ones required by MC5P. The settings vary depending on the connected pressure controller (usually the default communication settings of the pressure controller). If the settings have been changed afterwards, refer to the pressure controller's manual on how to change the communication settings.

Note.

Although the pressure controller does measure the generated pressure, it is not passed on to MC5P in MC5P's Basic Mode. Therefore you should always connect the generated pressure also to a pressure measurement module in MC5P.

When a controller is used in Calibration Mode, Input Mode "Control" is used when the instrument's input signal is measured with MC5P and Input Mode "Ctrl/Mea" when the controller communicates the generated pressure to MC5P.

Zero the pressure controller using its own user interface or program it to zero itself every time it generates zero pressure.

Temperature Controller Settings

The following temperature controller manufacturers have models that communicate with MC5P (the list was valid when this User Guide was written):

- TekKnow
- Isotech
- Ametek/Jofra SE, ATC, CTC and ITC models,
- HART Scientific, most Industrial Models.

When in doubt whether your controller type or model communicates with MC5P, contact Beamex support. E-mail: support@beamex.com or use the contact info available on the prepages of this manual.

The following settings apply in general to all supported temperature controllers. If certain controllers have device specific data, it is mentioned in the general description.

Device Address

The Device Address of **TekKnow TC1200** and **Isotech** is either **1** or **2**, depending on the device configuration.

The Device Address field is not visible for temperature controllers that **do not need** the setting.

Serial communication settings

The communication settings shown in the window are the ones required by MC5P. The settings vary depending on the connected temperature controller (usually the default communication settings of the temperature controller). If the settings have been changed afterwards, refer to the temperature controller's manual on how to change the communication settings.



Note.

Although the temperature controller does measure the temperature of the bath/dry block it is not passed on to MC5P in MC5P's Basic Mode. Therefore it may be of use to also connect a temperature sensor to a suitable port in MC5P.

When a controller is used in Calibration Mode, Input Mode "Control" is used when the instrument's input signal is measured with MC5P and Input Mode "Ctrl/Mea" when the controller communicates the temperature to MC5P.



Printing

When using the optional printer you may print out screenshots of any user interface screen (e.g. calibrations results) in MC5P.

You can print the screenshot by pressing the  key and the  key simultaneously. MC5P responds with a long beep to indicate that the screen is dumped to the printer.

The printer can not be used at the same time as MC5P is connected to a computer because the printer and the computer uses the same interface (the COMP/PRT connector).

Notes.

If you press the  and  keys and no printer is connected, the serial port is unavailable for PC communication for about a minute.

The printer is configured for communication with MC5P when delivered. If you inadvertently alter the configuration, please contact Beamex for instructions on how to restore the settings.

Warning!

Only use the printer provided by Beamex. Using any other printers may damage the printer or MC5P or even both of them.

Use only cables provided by Beamex when connecting MC5P to a PC or a printer.

Additional Information

Most of the measurements, generations and simulations presented in this manual are straight forward: Just make the required window settings and connect the instrument under test in the active terminals and that's it!

Some cases require additional settings and things to check before you can be certain that the measurement, generation or simulation works as expected. A typical example of this is temperature measurement using a thermocouple. It is not enough to select the correct quantity and port in MC5P. The Sensor type and the Reference Junction Mode has to be set accordingly, too. Wrong settings give erroneous results.

Whenever this additional information may be of use in a measurement, generation or simulation, text describing the function refers to one of the following chapters. An experienced user need not jump to read this supplemental text, but for a beginner we highly recommend it.

The main subjects described here are:

Things to Consider when Measuring Pressure on page 91,
Thermocouple Measurement/Simulation, Connections and Troubleshooting on page 93,
Resistance and RTD Measurement, Connections on page 97
Current Measurement Parallel to a Test Diode, Connections on page 99 and
Parallel Functions in MC5P on page 100.

Things to Consider when Measuring Pressure

General

MC5P can measure pressure with its internal pressure modules, or with external pressure modules. If a barometric module is present, the measurement results of other modules can be shown either as absolute pressure or as gauge pressure.

Pressure Type

Every pressure measurement is in fact a pressure difference measurement: a given pressure value is compared against a reference pressure. In certain cases the reference pressure has a special meaning (like the atmospheric pressure) and the pressure measurements with reference to against these points are given a special name:

- **Absolute pressure measurement** uses vacuum as the reference pressure.
- **Barometric pressure** (or **atmospheric pressure**) is the absolute pressure of the surrounding atmosphere. It is specially titled because of its importance.
- **Gauge pressure measurement** uses the atmospheric pressure as the reference. Gauge pressure may be zero, negative or positive. Most of MC5P's pressure modules actually measure gauge pressure although they may be used for measuring other pressure types too.
- **Differential pressure measurement** requires a special differential pressure module that has an input available for both the reference pressure and the given pressure.

To be able to measure absolute pressure with MC5P's gauge pressure modules, you need a barometric pressure module. Certain high pressure modules may approximate absolute pressure measurement by adding an entered barometric pressure to the measured gauge pressure.

MC5P may use two standard pressure modules to measure differential pressure: One module measures the reference pressure and another the given pressure. The pressure difference is calculated by subtracting the reference pressure from the given pressure. More of this in Part B, chapter **Special Measurements**.

Always ensure that the pressure type setting of your pressure measurement is what you intended it to be. The pressure type setting is crucial for getting meaningful pressure measurement results.

Pressure Modules and their Naming Conventions

MC5P's software refer to pressure modules as follows:

Port: Module Name, e.g. P1: INT400m

which means that there is an internal pressure module in port **P1** with a 0 to **400 mbar** (0 to 6 psi) pressure range.

The names of internal pressure modules start with the letters **INT**. The names also include numbers and possible additional letters as follows:

1. The number defines the max. nominal pressure in the SI pressure unit **bar**.
2. If the number is followed by a small "**m**", the given max. nominal pressure is given in **mbar**.
3. If there is an additional letter **C**, the pressure module is a compound module with an ability to also measure negative gauge pressures.

Examples:	Name	Max. nominal pressure	in psi
	INT100m	100 mbar	1.5
	INT400mC	± 400 mbar	± 6
	INT2C	-1 ... 2 bar	-14.5 ... 30

Notes.

Compound modules with a max. nominal pressure above 1 bar (e.g. INT2C) are able to measure negative pressures down to -1 bar. Compound modules with a max. nominal pressure below 1 bar (e.g. INT400mC) are only able to measure as deep negative pressures as positive pressures.

The name of the internal barometric pressure module is **B**.

Eternal pressure modules have a name that starts with the letters **EXT**. The name includes numbers and possibly an additional letter similar to internal modules (does not apply to old **XPMs**).

Square Rooting

Pressure transmitters or converters used for flow measurement often have square rooting character. To enable correct percentage error calculation of square rooting transmitters, select "square rooting" as the Transfer Function.

Square rooting is required when entering instrument data for a pressure instrument (see Part D, Calibration). Standard pressure measurement in Basic Mode does not require any Transfer Function information.

Thermocouple Measurement/Simulation, Connections and Troubleshooting

To accurately measure the thermovoltage caused by the temperature to be measured, the second thermovoltage caused by the Reference Junction needs to be compensated. This is done using one of the Reference Junction compensation methods described in the subsequent chapters.

The Reference Junction compensation method has to be chosen both when measuring and simulating thermocouples.

Internal Reference Junction

If the measuring/simulating port is set to the Internal Reference Junction Module (ET: TCi(mea) or ET: TCi(sim)), MC5P automatically selects the Internal Reference Junction compensation method. No other Reference Junction compensation methods are available unless the measuring/simulating port is changed.

Connection when measuring/simulating thermovoltage using Internal Reference Junction Mode:

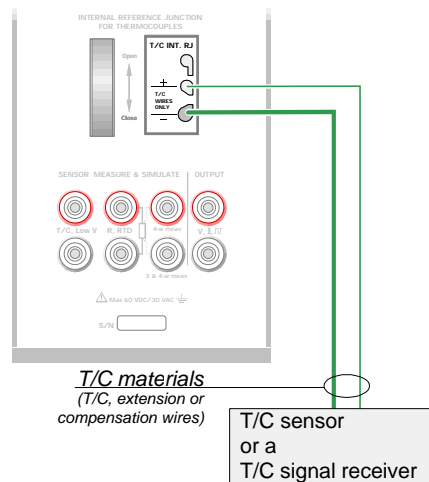

Note.

The range of the Internal Reference Junction's temperature compensation is $-10 \dots +50^{\circ}\text{C}$ ($14 \dots 122^{\circ}\text{F}$).

See also...

External Reference Junction on page 94

External Reference Junction

When using an external Reference Junction, MC5P measures or simulates the thermovoltage using the “T/C Low V” terminals in the ET section. If the measuring/simulating port is set to the External Reference Junction (ET: TCx(mea) or ET: TCx(sim)), the following Reference Junction compensation methods are available:

RTD sensor:
To be used when:

- The Reference Junction temperature is measured using an RTD sensor connected to MC5P’s RTD terminals.

Connection when measuring/simulating thermovoltage using Reference Junction compensation method RTD sensor:

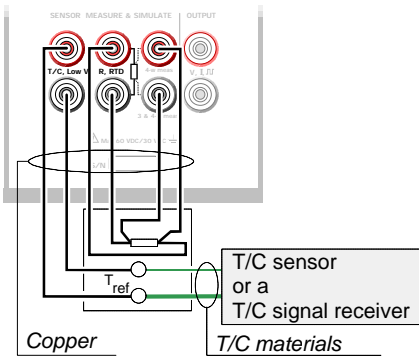

Warning!
If you connect an RTD sensor to the ET module’s R, RTD connectors, there is no galvanic isolation between the thermocouple and the RTD sensor.

0°C:
To be used when:

- The Reference Junction temperature is **fixed** to 0°C (using, e.g. ice) and MC5P is not used for measuring the Reference Junction temperature.
- The Reference Junction temperature is **controlled** with 0°C set point.
- A compensation box is used and the Reference Junction temperature setting is 0°C.
- There is no Reference Junction compensation in the measuring/simulation circuit but 0°C is a good enough approximation.

Entered:
To be used when:

- The Reference Junction temperature is **fixed** to a temperature that differs from 0°C.
- The Reference Junction temperature is **controlled** and the controller’s set point is not 0°C. Note: this method is of use only if the accuracy of the controller is better than MC5P’s own Reference Junction Module.
- A compensation box is used and the Reference Junction temperature setting is other than 0°C.
- There is no Reference Junction compensation in the measuring/simulation circuit, but you want to manually enter another Reference Junction temperature than 0°C.

Connection when measuring/simulating thermovoltage using a temperature controller and Reference Junction compensation method Entered (also RJ-mode 0°C):

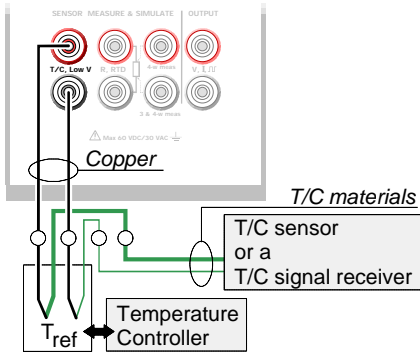

Connection when measuring/simulating thermovoltage using a compensation box and Reference Junction compensation method Entered (also RJ-mode 0°C):

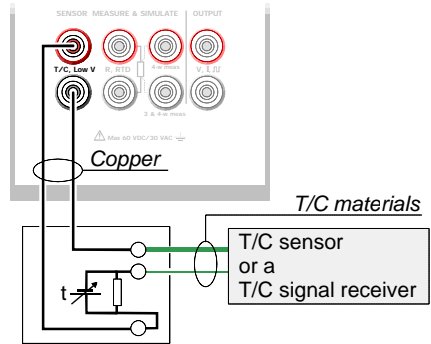

Connection when measuring/simulating thermovoltage using a fixed temperature and Reference Junction compensation method Entered (also RJ-mode 0°C):

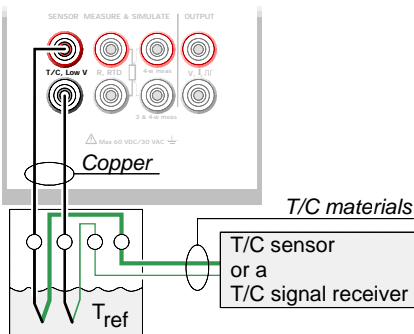

See also...

Internal Reference Junction on page 93

Error situations

The easiest way to avoid errors in thermocouple measurement and simulation is to check carefully the used wiring and the Reference Junction mode. The following table describes the typical error situations and possible causes/corrections when working with thermocouples:

PROBLEM	CAUSE
<p>MC5P (or the instrument under test when simulating thermovoltages) measures the temperature/millivolt signal, but the displayed temperature reading is all wrong. (The error may vary from 0 to about $\pm 50^{\circ}\text{C}$ depending on the type of the error)</p>	<ul style="list-style-type: none"> • The thermocouple type selected in MC5P does not correspond with the used thermocouple. • The selected Reference Junction mode is not in accordance with the used wiring. • Extension or compensation cable type or connections are incorrect. • The polarity of the cables are incorrect.
<p>MC5P (or the instrument under test) displays random readings during thermocouple measurement.</p>	<ul style="list-style-type: none"> • Incorrect connections. • The wiring is broken. • Interference from a mobile phone or a radio transmitter affects the measurement.
<p>MC5P displays unstable readings during thermocouple simulation.</p>	<ul style="list-style-type: none"> • The instrument under calibration uses voltage pulses to detect open sensor. When MC5P detects these pulses, it tries to compensate for them, which causes the unstable output. Prevent these pulses for the time of calibration. Refer to the service manual of the instrument under calibration on how to prevent these open sensor detection pulses.

Resistance and RTD Measurement, Connections

The two main problems in resistance and RTD measurement are the effects of wiring resistances and thermovoltages in the resistance measurement circuit. If possible, use 4-wire connection to eliminate the effect of wiring resistance. The special resistance measurement sequence of MC5P eliminates the thermovoltages of the resistance measurement circuit.

MC5P continuously checks the connection type during resistance and RTD measurement. The found connection type is displayed on the resistance or RTD measurement window.

4-wire System

MC5P sources current through the resistor from the two left side terminals. MC5P measures the voltage drop across the resistor from the two right side terminals. The 4-wire method gives the resistance between the terminals of the resistor, it is insensitive to the resistance of the connection wires.

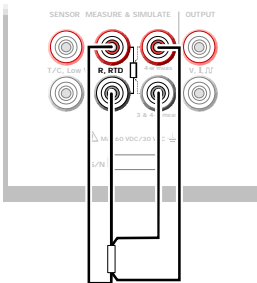

3-wire System

MC5P sources current through the resistor from the two left side terminals. MC5P measures the voltage drop across the entire current loop and across the low side connection wire. If both left side connection wires are identical, MC5P can compensate for the resistance of the connection wires.

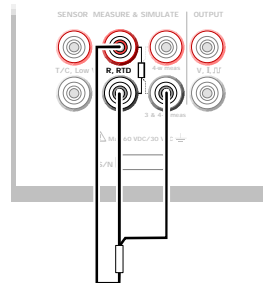

Using a Compensation Loop

MC5P sources current through the resistor and the compensation loop from the two left side terminals. MC5P measures the voltage drop across the entire current loop and across the compensation loop. If the compensation loop and the connection wires of the resistor are identical, MC5P can compensate for the resistance of the connection wires.

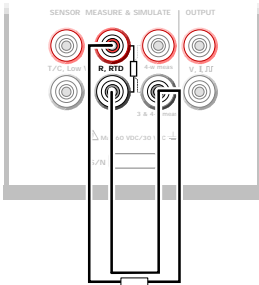

When the compensation loop wiring system is used, MC5P displays the text “3-wire”.

2-wire System

Calibrator sources current through the resistor and measures the voltage drop across the same terminals.

The result is acceptable, if the resistance of the connection wires is low.

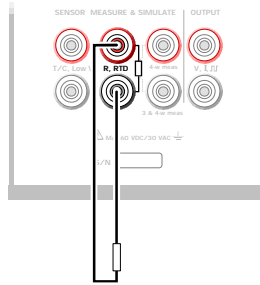

Current Measurement Parallel to a Test Diode, Connections

The impedance of MC5P's milliampere input is low enough to enable current measurement parallel to a test diode in a 20 mA circuit. Connections:

Plus Side Test Diode

Minus Side Test Diode

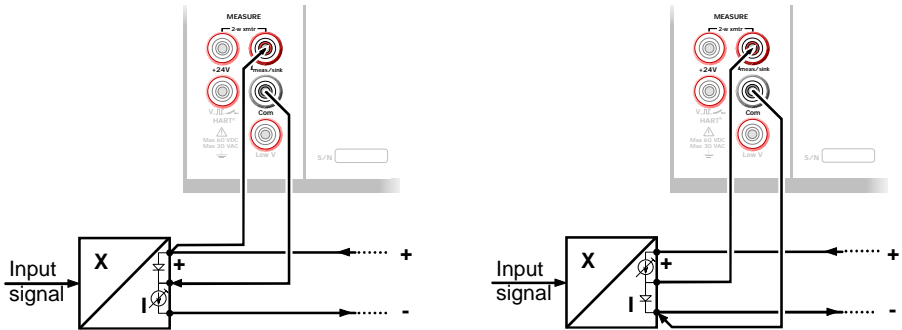

MC5P parallels the test diode of the transmitter and measures the externally supplied output current of the transmitter. For more information concerning test diode connections of HART instruments, see Appendix 1, chapter **Connecting MC5P and a HART Instrument** on page 138.

Note.

In higher temperatures: The leakage of the diode in the instrument may affect the accuracy.

Parallel Functions in MC5P

This chapter explains what kind of simultaneous tasks you can do with MC5P.

Every module in MC5P may simultaneously have their own tasks. Also every available output connector (ENV, AUX and COM/PRT) may have their own independent tasks.

The ET module has a double action ability: When one of the sensor measure & generate section terminals (T/C INT RJ, T/C Low V, or R,RTD terminals) is used for **measuring** purposes. Then an electrical output signal may be generated from the ET module's output terminals. This feature is not available when **generating** a signal from the sensor measure & generate section terminals.

The ET module is also capable of doing the following double tasks:

- Measuring Low Voltages or thermocouples (connected to any terminal used when measuring thermocouples) and at the same time either measuring or simulating an RTD with the RTD sensor terminals.
- Generating Low voltages or simulating a thermocouple (connected to any terminal used when simulating thermocouples) and at the same time measuring with the RTD sensor terminals.

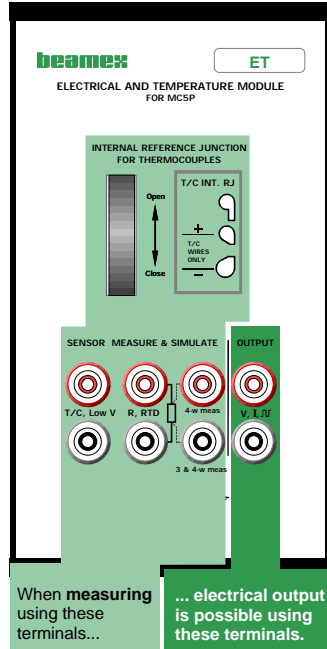

Warning!

There is no galvanic isolation between the ET module's measuring terminals and generating terminals.

Calibration

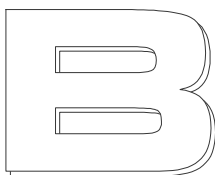
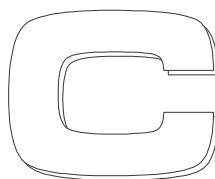

Things discussed in Part D:

- General presentation of what calibration is and the phases of a typical calibration procedure.
- A description of a calibration procedure using MC5P.
- Some application examples on how to perform the calibration of certain instruments.
- Creating, editing and deleting Instruments.
- Viewing calibration results.

General

MC5P is a stand-alone calibrator as well as a calibrator communicating with calibration software.

MC5P supports **stand-alone calibration** and **off-line calibration**. The following list briefly describes these methods:

- In stand-alone calibration, all instrument and calibration result data is stored in MC5P's memory. No external calibration database is used.
- In off-line calibration (sometimes also called batch calibration), the instrument data is downloaded from a calibration software. The calibration is done just as in stand-alone calibration, but calibration procedures are downloaded from a software and the saved results are uploaded to the calibration software.

Off-line calibration requires the QCAL option. It also requires the computer communication cable to connect MC5P to a PC's serial port.

Note.

MC5P also includes a serial communication protocol option. With the option, it is possible to control MC5P via the COMP/PRT port to perform, e.g. a remotely controlled calibration. The communication protocol specification can be obtained from Beamex.

Phases of Instrument Calibration

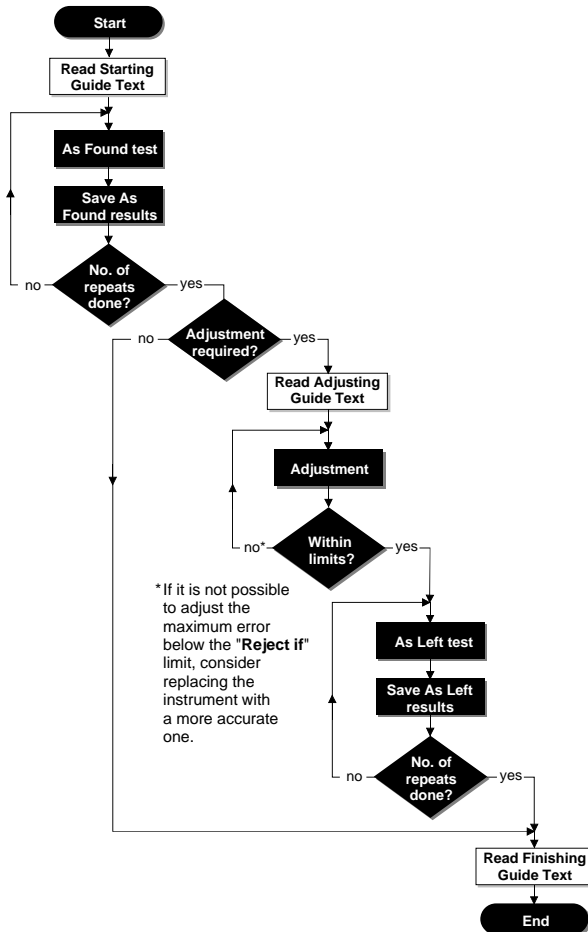

The picture gives a general view of the phases in a calibration procedure. MC5P supports three separate phases guide texts (white blocks in the picture):

One is displayed when starting the calibration.

Another when the adjustment utility is started.

The third text is displayed when ending the calibration.

The guide texts may be entered in MC5P or they may be downloaded from a PC with a calibration software.

As Found Calibration

The As Found calibration documents the state of the instrument before carrying out any adjustments. The calibration states the amount of drift in the instrument during the calibration period.

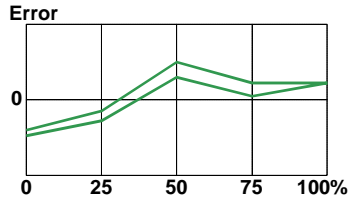

MC5P supports multiple As Found tests. There is no fixed upper limit for the number of repeats except the available free memory.

MC5P does not require you to save any As Found calibrations. If you do not want to save information of the instrument's state before adjustment, just do the adjustments needed and perform as many As Left calibrations as is needed.

Adjustment

MC5P calculates (among other figures) the maximum error found during the calibration. Depending on the value of the maximum error, you decide whether you adjust the instrument or not. MC5P supports four different error limit settings:

- Reject if** > acceptance limit for found maximum error,
- Adjust if** > the instrument need to be adjusted if this limit is exceeded,
- Do not adjust if** < adjusting the instrument is not necessary / of use and
- Adjust to** < after adjusting, the maximum error should not exceed this limit.

MC5P has a special adjustment utility tool that can be used when the input signal of the instrument is generated/simulated with MC5P. See chapter **MC5P's Support for Instrument Adjustment** on page 123. We recommend you use the utility whenever possible. In all other situations, use the error graph and its error value to have a view on how the adjustment affects the accuracy of the instrument and how close the output signal is from the target value.

Use the instrument's ZERO adjustment at lower end of the range. Adjust the higher end of the range with the instrument's SPAN adjustment. The two adjustment points do not necessarily need to be the end points of the instrument range. You may want to use other

points to optimize the calibration at the most important part of the range. Note, however, that if the points are very close to each other, the error at other points of the range may be quite big (see **As Left Calibration** on page 105).

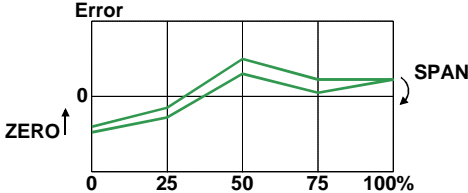

As Left Calibration

Multiple As Left calibrations are allowed just as they are for As Found calibrations. The As Left calibrations document the state of the instrument after the possible adjustment.

MC5P does not require you to save any As Left calibrations. If the As Found calibration proves to be good and no adjustment is needed, you may omit the As Left calibrations.

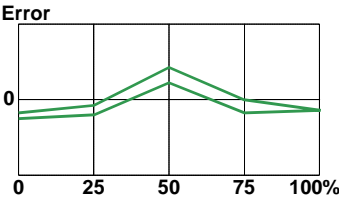
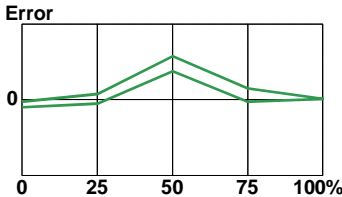

The pictures above display different As Left calibration graphs after two different kinds of adjustments.

In the leftmost picture, the error is minimized at the end points of the instrument range. This results in a relatively notable error in the middle of the span. If the middle of the span is the area, where the measurement is usually situated, then this method is not recommended.

The rightmost picture displays the error graph when the maximum error is minimized by “lowering the graph”. As a result, the error minimum is at approx. 30 % and 70 % of the span.

Note that these adjustment strategies are just examples. There is an unlimited amount of “correct” ways to adjust an instrument.

Required Modules for Different Input/Output Signal Combinations

Consider the type of your instrument before doing a calibration:

- What are the input and output quantities/ports?
- Is the input signal measured, generated/simulated, controlled or keyed (Input method)?
- Is the output signal measured or keyed (Output method)?

Use the following tables find out the required modules for each supported input/output quantity and method:

Table for choosing the input module		
QUANTITY	METHOD	REQ. MODULE
Voltage	Measured	E
	Generated	ET
	Keyed	none
Low Voltage	E measured	E
	ET measured	ET
	Generated	ET
	Keyed	none
Current	Measured	E
	E generated	E
	ET generated	ET
	Keyed	none
Resistance	Measured	ET
	Simulated	ET
	Keyed	none
Pressure	Measured	INT or EXT
	Controlled	INT or EXT
	Controlled/Meas	none
	Keyed	none
Temperature	Keyed	none
	Controlled/Meas	none
TC temperature	Measured	ET
	Controlled	ET
	Controlled/Meas	none
	Simulated	ET
RTD temperature	Measured	ET
	Controlled	ET
	Controlled/Meas	none
	Simulated	ET
Frequency	Measured	E
	Generated	ET
Value	Keyed	none
	Keyed	none

Table for choosing the output module		
QUANTITY	METHOD	REQ. MODULE
Voltage	Measured	E
	Keyed	none
	HART	E
Low Voltage	E Measured	E
	ET Measured	ET
	Keyed	none
	HART	E
Current	Measured	E
	Keyed	none
	HART	E
Resistance	Measured	ET
	Keyed	none
	HART	E
Pressure	Measured	INT or EXT
	Keyed	none
	HART	E
Temp.	Keyed	none
	HART	E
TC temperature	Measured	ET
	Keyed	none
	HART	E
RTD temperature	Measured	ET
	Keyed	none
	HART	E
Frequency	Measured	E
	Keyed	none
	HART	E
Value	Keyed	none
Switch	Measured	E

The general principle is: The same module may not be used for both the input and the output signal. There are however some exceptions to that rule:

- If the input signal is a current signal measured or generated using the E module, then any quantity with the output method HART may also be connected to the E module.
- If when checking the required modules both the input and the output module is ET, but the cells are grayed, check the table below. It presents all supported combinations where both the input signal and the output signal is connected to the ET module.

Supported input/output quantities and methods where both the input signal and the output signal is connected to the ET module:			
INPUT QUANTITY	INPUT METHOD	OUTPUT QUANTITY	OUTPUT METHOD
Voltage	Generated	Low Voltage	ET Measured
	Generated	TC Temperature	Measured
	Generated	RTD Temperature	Measured
Low Voltage	ET Measured	RTD Temperature	Measured
	ET Generated	RTD Temperature	Measured
Current	ET Generated	Low Voltage	ET Measured
	ET Generated	TC Temperature	Measured
	ET Generated	RTD Temperature	Measured
TC temperature	Measured	RTD Temperature	Measured
	Controlled	RTD Temperature	Measured
	Simulated	RTD Temperature	Measured
RTD temperature	Measured	TC Temperature	Measured
	Controlled	TC Temperature	Measured
	Simulated	TC Temperature	Measured
Frequency	Generated	Low Voltage	ET Measured
	Generated	TC Temperature	Measured
	Generated	RTD Temperature	Measured
	Generated	Resistance	Measured

Each row is a supported combination.



Calibrating an Instrument

Selecting the Instrument to Be Calibrated

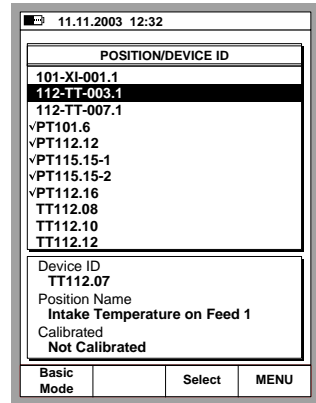
To move from Basic Mode to Calibration Mode, press the A/Calibration Mode Function Key. A list of instruments available in MC5P's memory is presented. If you do not have any instrument data in MC5P's memory, either download them from a calibration software or create instruments in MC5P as described in chapter **Adding New Instruments** on page 124. The Position ID / Device ID of an already calibrated instrument is tick-marked (✓).



When you move the cursor (the inverted text), the additional data presented in the lower part of the screen changes to reflect the data of the current instrument.

Select one of the available instruments by pressing the ,  or the C/Select key.

Note.

If there are a lot instrument data in MC5P's memory, displaying the list may take a few seconds.

The Instrument Window

The Instrument window gives you an overview of the selected instrument. You can view detailed instrument data by pressing the D/MENU Function Key and 1/View Instrument Details.

To edit the Instrument data, press the B/Edit Function Key. More information on editing instrument data is in chapter **Editing Instrument Data** on page 125.

If your instrument is calibrated using an external device that is communicating with MC5P, select D/MENU Function Key and 7/Controller Settings to select the device and start the communication.

To calibrate the selected instrument, simply press C/Calibrate. General calibration procedures are discussed in chapter **A Calibration Procedure Using MC5P** on page 110. Some calibration examples are available starting from chapter **Examples of Instrument Calibration** on page 113.

If a Starting Guide text is written, it appears before the Calibration Windows are opened. To close the window displaying the note text, press D/OK.

11.11.2003 13:01	
<u>INSTRUMENT</u>	
112-TT-003.1	
Intake Temperature on Feed 1	
Transfer Function	Linear
Cal. Points	5 - "
<hr/>	
INPUT	0.00 ... 100.00 °C
Method	Simulated
Sensor Type	Pt100 a385
<hr/>	
OUTPUT	4.0000 ... 20.0000 mA
Method	Measured
<hr/>	
← Back	Edit
Calibrate	MENU

A Calibration Procedure Using MC5P

The Calibration Windows:

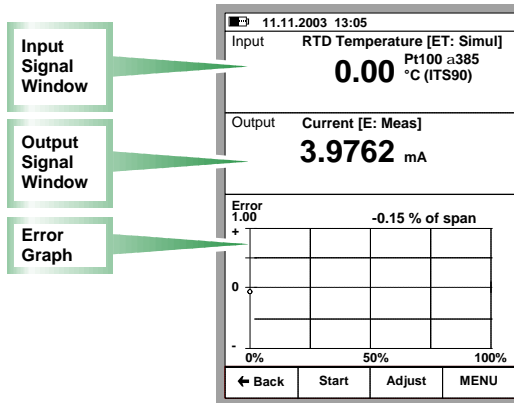

A typical calibration procedure using MC5P is as follows:

*We assume you have already selected the instrument to be calibrated and are viewing/editing the selected instrument's data pages. See **Selecting the Instrument to Be Calibrated** on page 108 for information on how to enter Calibration Mode and selecting instruments for calibration.*

1. Make the required connections and test them by altering the input signal in with the Instrument Adjustment utility (if you haven't done the connections and testing in Basic Mode).
2. Start the calibration run by pressing B/Start. The way MC5P passes through all calibration points depends on the Calibration Method setting:

In **Automatic calibration** MC5P generates/simulates (or communicates with an external device capable of generating/simulating) the input signal. See chapters

About Automatic Calibration on page 112 and
About Manual Calibration on page 112.

Note.

You can pause a calibration run whenever you want by pressing the A/Stop Function Key. Then you are provided with the following (self-explanatory) choices:

- A/Continue
- B/End
- C/Skip Point.

- When the calibration run is ready, you can either Reject the results (A/Reject Calibration) or Continue by pressing the D/Save → Function Key.

Note.

If the maximum error of the calibration results exceed the Adjust if > error limit, a message window with the following text:

"The calibrated instrument need to be adjusted."

- Enter the environmental data and save the results using one of the options provided in the Function Keys B to D.

Note.

Some of the temperature data may be pre-entered by MC5P, provided the data is available for MC5P (pressure modules, the E module, the ET module or the optional ENV sensor was used during the calibration).

- Continue either with another calibration run or end the calibration procedure. In the latter case you will see the possible Finishing Guide text before you are back viewing the Instrument Data.

Note.

If you are calibrating instruments using off-line method then please keep in mind this: When you upload the results from MC5P to the calibration software, the results are by default also left in MC5P's memory. To free memory in MC5P by deleting the results, see **Deleting Instruments** on page 128.

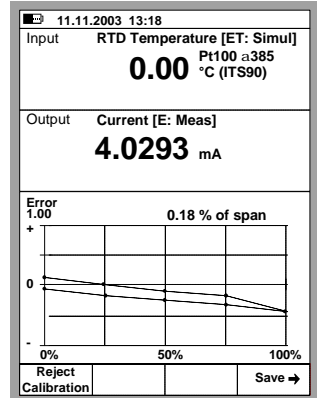

11.11.2003 13:19

ENVIRONMENTAL DATA

Device Temperature 21.0 °C

Environment Temp. 21.0 °C

Input Module Temp. 31.6 °C

Output Module Temp. 29.6 °C

Humidity 30 %

Calibrated by: Andy Handyman

Notes: Just Testing

← Back Save As Found Save As Left Save As Both

See also:

MC5P's Support for Instrument Adjustment on page 123.
Viewing Calibration Results on page 129.

About Automatic Calibration

Automatic calibration is possible when MC5P is able to generate/simulate the input signal. Another way to automate the calibration is allowing MC5P to control a connected external device capable of generating/simulating the input signal, e.g. a POC4 Pressure Output Controller connected to MC5P.

Automatic calibration is selected in the Calibration Method field on the Instrument Data pages. More information on editing instrument data is in chapter **Editing Instrument Data** on page 125.

In **Automatic calibration** MC5P generates/simulates (or communicates with an external device capable of generating/simulating) the input signal. When the input signal is within the **Maximum Allowed Calibration Point Deviation** limits, MC5P waits for the output signal to stabilize (the Setpoint Delay setting). Then the calibration point is accepted automatically and MC5P continues with the next calibration point.

If the input signal never stabilizes (the  symbol is visible continuously), but you want MC5P to save the results anyhow, press the B/Force Accept Function Key.

About Manual Calibration

In manual calibration, you will have to manually set the input signal to a level that the next calibration point requires. Manual calibration is possible in almost all situations. Even for calibrations that could be done automatically.

If the input signal is measured, the input signal window displays a “Desired Input Value X.xxxx” text to help you remember what is the next target value.

If the input signal is generated/simulated, MC5P automatically changes the input signal to the next target value, but does not continue until you manually accept the point.

Use the B/Accept Readings Function Key to save the point data and continue to the next point until all points are accepted.

Notes.

If the calibration points are defined for the output signal, set the input signal to such a level that the instrument to be calibrated creates the required output signal.

See also **Autocapture Feature** on next page

Autocapture Feature

The Autocapture Feature makes it possible to make a manual calibration that is semi-automatic when the input signal is measured. To be able to utilize the Autocapture Feature the instrument data has to be set as follows:

- Input Method field set to “Measured”,
- Calibration Method field set to “Automatic” and
- Maximum Allowed Calibration Point Deviation field set to greater than zero.

Then MC5P tracks the input signal and once the input signal is inside the Maximum Allowed Calibration Point Deviation limit for a time period defined in the Setpoint Delay, the input and output values are automatically saved.

Activate the Autocapture Feature from the menu available when viewing the calibration windows. When activated and a calibration point is about to be captured (MC5P is waiting for the Setpoint Delay time to pass while the measurements are stable enough and within the Maximum Allowed Calibration Point Deviation limit), an hourglass is shown in the input measurement window's lower right corner.

When autocapture “snatches” the input and output signal values, MC5P emits a beep and the next target value for the input is displayed.

Examples of Instrument Calibration

This User Guide has only a few examples of how to calibrate an instrument. Many calibration procedures not presented here are either very similar to the ones presented in the following chapters or they can be “combined”, e.g. the calibration of a **Pressure Indicator/Recorder** is partly done as a **Pressure Transmitter** and partly as a **Temperature Indicator/Recorder** calibration.

Use the information presented in Part B of this manual when connecting/calibrating instruments that do not have a separate calibration procedure presented in this part.

The following calibration examples are presented in this manual:

Pressure Transmitters on page 114,

Temperature Sensors on page 116,

Temperature Indicators and Recorders on page 118 and

Electrical Limit Switches on page 120.

Pressure Transmitters and Sensors

This procedure suits all instruments with a pressure input and any kind of electrical output signal. Both the input and output signal range should be measurable with MC5P. To be able to perform an automatic calibration, MC5P needs to have the firmware option required to communicate with the pressure controller.

Required modules

- An internal or external **pressure module**.
- The **E module** for measuring the electrical output signal.

Preparations

1. Connect the input signal of the instrument to the pre-selected pressure module (INT, EXT, XPM). If you are calibrating a pressure sensor, and have configured MC5P to provide the supply voltage or current, connect the **ET module's** output terminals (marked with a circle in the picture) to the sensor's supply terminals. For more information on sensor supply configuration, see chapter **Instrument Input Page** on page 126.
2. Connect the pressure source both to the instrument's input and to the pre-selected pressure module (INT, EXT, XPM). If a pressure output controller is used, connect it to MC5P's AUX interface.
3. Connect the instrument's output signal to the chosen electrical input port in MC5P.
4. Test the connections in Basic Mode if needed. To quickly configure the Basic Mode's windows, go to Calibration Mode, select the instrument to be calibrated and the Function Key C/Calibrate but immediately return to Basic Mode.

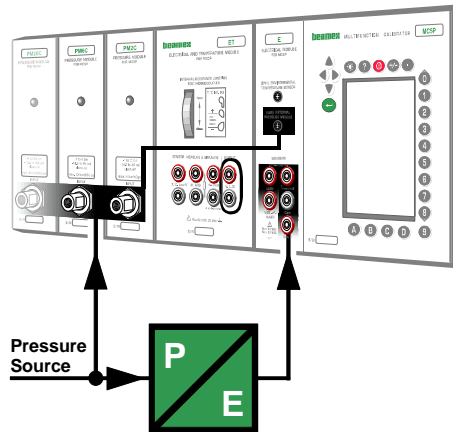

Calibration

1. Move to Calibration Mode and select the instrument to be calibrated. If applicable, activate the pressure controller communication as described in chapter **The Instrument Window** on page 109.
2. Start the calibration as presented in chapter **A Calibration Procedure Using MC5P** on page 110.
3. Set the pressure manually using, e.g. a pressure pump. If a pressure controller is connected to MC5P, the pressure controller generates the pressure based on MC5P's requests.
4. In manual calibration: Accept the points using the B/Accept Readings Function Key. The calibration proceeds automatically if a pressure output controller is available and the Calibration Mode is set to Automatic. Additional Calibration Method specific data is in chapters **About Automatic Calibration** and **About Manual Calibration**, both on page 112.
5. Save or reject the results as is described in chapter **A Calibration Procedure Using MC5P** on page 110.
6. Either do another calibration run or return to the Instrument window.

Hint!

These instructions can be adapted for **pneumatic pressure transmitters** and **converters**, too. Instead of connecting the output signal to a terminal in the E module, connect the pressure output signal to a suitable pressure module.

Warning!

Working with pressure instruments can be hazardous. Only qualified personnel may use pressure instruments and pressure sources.

Next...

MC5P's Support for Instrument Adjustment on page 123.

Temperature Sensors

This procedure suits temperature sensors no matter if they are RTDs or thermocouples. The sensor's output signal is measured with MC5P or it is keyed into MC5P. The reference temperature is either measured with MC5P or it is entered or communicated (Input Method Controlled/Meas) to MC5P. Automatic calibration requires the firm-ware option for communicating with the calibration bath / dry block.

If you measure the reference temperature using MC5P, remember the following conditions:

- If the sensor to be calibrated is a thermocouple, the reference thermometer needs to be an RTD sensor.
- If the sensor to be calibrated is an RTD sensor, the reference thermometer needs to be a thermocouple.

Required modules

- The **ET** module for measuring the sensor's output signal and possibly also for measuring the reference temperature.

Preparations

1. Connect the calibration bath / dry block to MC5P's AUX connector (if applicable) using the communication cable provided with MC5P. Place the sensor of the instrument (and the sensor of the reference thermometer) into the calibration bath/dry block. Connect it/them to suitable terminals in MC5P (RTD or T/C). If the sensor is a thermocouple, select one of the available reference junction methods:
2. Test the connections in Basic Mode if needed. To quickly configure the Basic Mode's windows, go to Calibration Mode, select the instrument to be calibrated and the Function Key C/Calibrate but immediately return to Basic Mode.

- The internal Reference Junction module is in use.
- The reference junction is fixed to 0°C.
- The reference junction temperature is entered.
- The reference junction temperature is measured externally using an RTD connected to the RTD terminals.

See Part C for additional information concerning the reference junction methods.

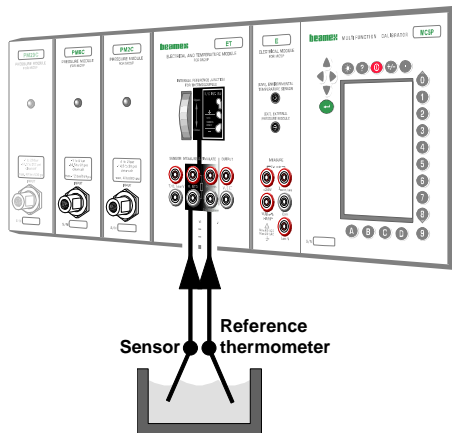

Calibration

1. Move to Calibration Mode, select the instrument to be calibrated and start the calibration as presented in chapter **A Calibration Procedure Using MC5P** on page 110.
2. Start the calibration as presented in chapter **A Calibration Procedure Using MC5P** on page 110.
3. Set the temperature of the bath/dry block to the required calibration point. If the temperature bath/dry block communicates with MC5P, MC5P controls the temperature of the bath/dry block. Wait until the temperature stabilizes.
4. If the reading of the reference temperature sensor is entered manually, enter the value and press B/Accept Readings Function Key. If the reference temperature sensor is connected to MC5P and the Calibration Method is Manual, accept the readings using the B/Accept Readings Function Key. In automatic calibration the calibration proceeds automatically. More information on Calibration Methods is in chapter **About Automatic Calibration** and **About Manual Calibration**, both on page 112.
5. Save or reject the results as is described in chapter **A Calibration Procedure Using MC5P** on page 110.
6. Either do another calibration run or return to the Instrument window.

Hint!

With small changes, this procedure should also suit all temperature instruments with a fixed sensor. In that case, use a reference sensor that can be connected to MC5P to measure the input signal and either measure or enter the output signal of the instrument.

Use one of the following examples for the output signal:

- **Temperature Transmitter with sensor.** See the example **Pressure Transmitters** on page 114.
- **Temperature Indicators/Recorders with sensor.** See the example **Temperature Indicators and Recorders** on page 118.
- **Temperature switches (thermostats) with sensor.** See the example **Electrical Limit Switches** on page 120.

Next...

MC5P's Support for Instrument Adjustment on page 123.

Temperature Indicators and Recorders

This procedure suits Temperature Indicators/Recorders no matter if the sensor is an RTD or a thermocouple. The instruments input signal is simulated using MC5P and the output reading is entered into MC5P.

Required modules

- The **ET** module for simulating the temperature sensor. The Base Unit takes care of entered output signal.

Preparations

1. Connect suitable terminals in MC5P to the input connectors of the indicator/recorder.
2. If the sensor to be simulated is a thermocouple, select one of the following reference junction methods:
 - The internal Reference Junction module is in use.
 - The reference junction is fixed to 0°C.
 - The reference junction temperature is entered.
 - The reference junction temperature is measured externally using an RTD connected to the RTD terminals.
3. If the sensor to be simulated is an RTD, the used wiring system depends on the instrument to be calibrated. Remember to only use the two leftmost RTD terminals in MC5P.
4. Test the connections in Basic Mode if needed. To quickly configure the Basic Mode's windows, go to Calibration Mode, select the instrument to be calibrated and the Function Key C/Calibrate but immediately return to Basic Mode.

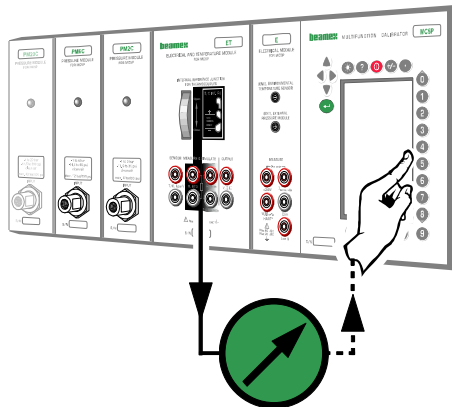

Calibration

1. Move to Calibration Mode, select the instrument to be calibrated and start the calibration as presented in chapter **A Calibration Procedure Using MC5P** on page 110.
2. MC5P simulates the output signal of the temperature sensor for each calibration point. The middlemost window displays the default value for the reading. You have two possibilities on how to continue:
 - Adjust the simulated signal until the reading of the indicator/recorder is exactly the same as the default value displayed in MC5P. This method is useful when calibrating analog indicators/recorders and the input signal source supports fine adjustment.
 - Select the field displaying the default value and enter the actual reading. This method is useful when calibrating indicators with digital display or when the input signal cannot be fine adjusted.
3. Accept the points using the B/Accept Readings Function Key.
4. Save or reject the results as is described in chapter **A Calibration Procedure Using MC5P** on page 110.
5. Either do another calibration run or return to the Instrument window.

Hint!

This procedure can be used as a reference when calibrating any kind of indicators/recorders. Adapt the input signal connections/settings according to the instruments input signal.

When calibrating a temperature instrument with a detachable sensor (the input signal is simulated with MC5P), use this example as the source for the input signal part.

Next...

MC5P's Support for Instrument Adjustment on page 123.

Electrical Limit Switches

This procedure suits limit switches with an electrical input. The input signal is generated with MC5P.

Required modules

- The **ET** module for generating the required electrical signal (Voltage or Current).
- The **E** module for detecting the switch's state.

Preparations

1. Connect the ET module's terminals marked "OUTPUT" to the input of the switch.
2. Connect the switch contact to the switch terminals in the E module.
3. Test the connections in Basic Mode if needed. To quickly configure the Basic Mode's windows, go to Calibration Mode, select the instrument to be calibrated and the Function Key C/Calibrate but immediately return to Basic Mode.

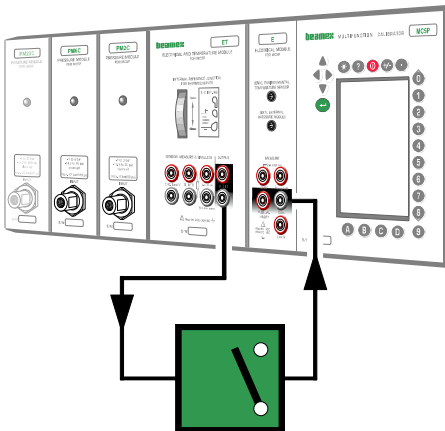

Calibration

1. Move to Calibration Mode and select the instrument to be calibrated.
2. Start the calibration as is presented in chapter **A Calibration Procedure Using MC5P** on page 110. MC5P does the Prescan if it is enabled. During the prescan, MC5P searches for approximate values for the actuating and deactuating point. This speeds up the final test without sacrificing accuracy. The prescan test is done only once in a calibration.
 - By default, the Prescan is set to on. If you do not want MC5P to perform a prescan, disable it (commands D/MENU and 2/Prescan). When Prescan is set to off, MC5P uses the whole scan range also during the actual test.
3. The actual test is done automatically: MC5P slowly increases the input signal until the switch actuates and continues by decreasing the input signal until the switch deactuates. MC5P's screen displays the obtained data as the test advances.

- If for some reason the calibration cannot be done automatically (because the input signal is measured, not generated/simulated), you will have to change the input signal manually. The slower you raise the input signal the more accurate the observed actuation point is. Be equally careful when decreasing the input signal in order to get the deactuation point.
4. Save or reject the results as is described in chapter **A Calibration Procedure Using MC5P** on page 110.
 5. Either do another calibration run or return to the Instrument window.

Notes.

Selecting Calibration Method Manual when the input signal is generated/simulated with MC5P means that each pair of actuation/deactuation points have to be accepted manually.

If the prescan stops and displays an error message, try widening the scan range. It is also advisable to have the scan range symmetrical in relation to the actuation/deactuation points.

Hint!

This procedure also suits other types of switches. How to calibrate other types of switches may be adapted by combining the information of this example with the input signal information from one of the following examples:

- **Pressure switches.** See the example **Pressure Transmitters** on page 114.
- **Temperature switches with a fixed sensor.** See the example **Temperature Sensors** on page 116.
- **Temperature switches with a detachable sensor.** See the example **Temperature Indicators and Recorders** on page 118.

Next...

MC5P's Support for Instrument Adjustment on page 123.

Using External Devices in Calibration Mode

In order to utilize external devices when calibrating an instrument, the following things need to be set/available before the calibration is started:

- The required firmware option has to be installed in MC5P (and when applicable, in the connected external device).
- The Instrument's Input Method field has to be set either to Controlled or Controlled/Meas. About the settings:
 - * Controlled: The input signal (pressure or temperature) is measured using one of MC5P's measurement input ports.
 - * Controlled/Meas: The input signal is measured by the external device and communicated to MC5P.

In both cases: MC5P sends the set point values to the external device via the communication cable connected to the AUX connector

- The Instrument's Calibration Method field has to be set to Automatic.
- In the Instrument Window: Select the D/Menu and 7/Controller Settings to select the Controller type and activate the communication.

Notes.

The Input Method option Controlled is available for the following Input Quantities: Pressure, RTD temperature and TC temperature.

The Input Method option Controlled/Meas is available for the following Input Quantities: Pressure, Temperature, RTD Temperature and TC Temperature.

More information on how to create instruments into MC5P's database and how to edit the settings of an existing instrument is available in chapter **Maintaining MC5P's Instrument Database** on page 124 and its subchapters.

Chapter **Generating Signals Using External Devices** on page 85 contains a description on how to utilize external devices in Basic Mode and also information on controller settings.

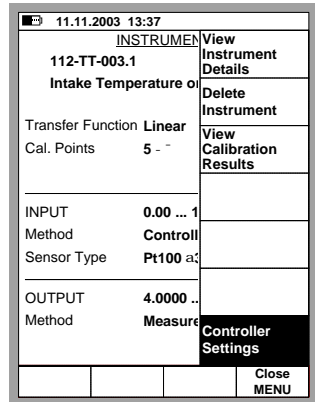

MC5P's Support for Instrument Adjustment

MC5P includes a special utility for adjusting instruments. This tool is of use when MC5P generates/simulates the input signal or controls an external device that generates/simulates the input signal (automatic calibration). Use the standard calibration screen when adjusting instruments that are calibrated manually. When viewing the three Calibration Windows, open the adjustment utility by pressing the C/Adjust Function Key. Press the Function Keys B, C and D to quickly change the value of the input signal.

Additionally, the input signal field is editable during instrument adjustment. This makes it possible for you to enter generation/simulation values other than the ones available via the Function Keys.

Hint.

For help on how to adjust/trim HART instruments, see Appendix 1.

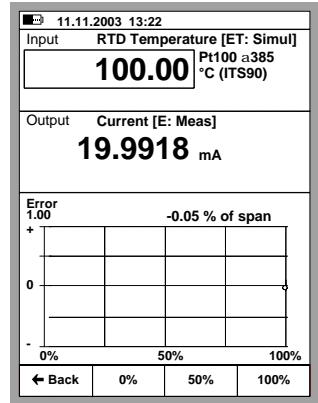

Maintaining MC5P's Instrument Database

This chapter and its subchapters describe how to create instruments, edit instrument data and delete instruments.



Adding instruments to MC5P's database by downloading the instruments from an external calibration database software is not presented here. When using such a software, consult the Instruction Manual of the software.

MC5P's memory is dynamic. There are no fixed amount instruments and calibration data that you may keep in MC5P's memory. It all depends on how many calibration repeats and how much history data is kept in the memory.

Normally, you can safely store some hundreds of instruments and their calibration results without having "out of memory" messages.

If you want to delete instruments or calibration data from MC5P's memory, see chapters **Deleting Instruments** on page 128 and **Deleting Calibration Results** on page 130.

Adding New Instruments

If you go to Calibration Mode, but there are no instruments in MC5P's database, the Position ID list is empty except for the possibility to create a new instrument. Select the  or the  key to create a new instrument. If the Position ID list is not empty, you can add new instruments by selecting D/MENU and 1/Create New Instrument.

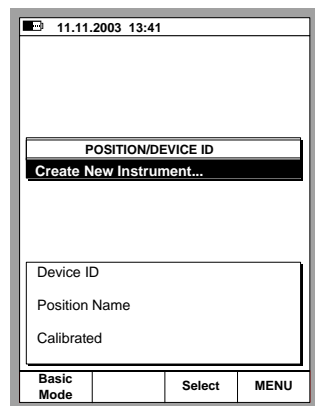

Whichever way you start creating the instrument, you will first have to select the Input Quantity and the Output Quantity. These selections cannot be changed afterwards.

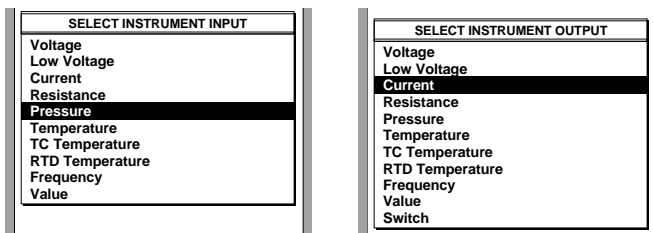

After the Quantity selections, there are five pages of instrument data that need to be completed. They are presented in chapter **Editing Instrument Data**.

Note.

There's also a possibility to create a new instrument based on an instrument already existing in MC5P's memory. Do this with the Copy Instrument option available in menu.

Editing Instrument Data

The instrument data pages may be re-edited whenever you want.

Note.

Only the following fields may be edited if the instrument data is downloaded from a calibration software (valid for Beamex's calibration software QD3 and QM6):

- Input Span and Output Span.

General Data Page

Out of the four text fields in the upper part of this page, only Position ID or Device ID is required. Change the Error calculation formula and the error limits according to your needs. Zero value in any error limit field means that the limit is not compared against the calculated maximum error.

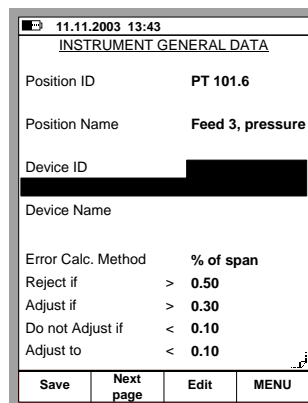

Instrument Input Page

The input quantity defines which fields are required/visible. Common fields for all quantities are:

Input Method,
Unit and
Range

All other quantities except Value also have the Input Port field.

Some additional fields appear when the input quantity is Pressure, RTD Temperature or T/C Temperature, e.g. Pressure Type in the adjacent picture.

The Sensor Supply fields at the bottom of the window are unique for pressure instruments. They allow configuring supply voltage or current to a pressure sensor.

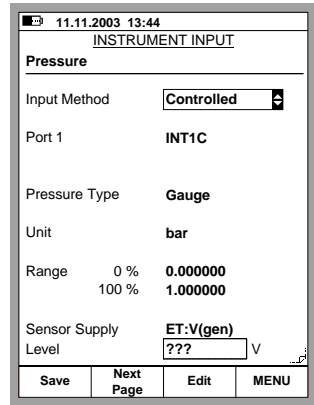

Instrument Output Page

The output quantity includes the corresponding common fields as the input quantity.

The same additional fields are also available for the output quantity, with the following exceptions/additions:

If the output quantity is Pressure, the pressure type is always "Gauge".

Output quantity Frequency includes a Trigger Level setting.

Remember to also check the Transfer Function setting at the bottom of the display. The default setting is Linear.

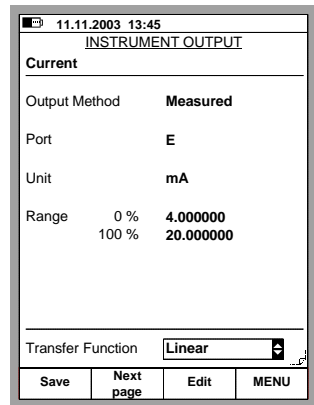

Switches have an altogether different group of settings as shown in the adjacent picture. The actuation and deactuation point errors are calculated against the corresponding nominal values.

Error Calculation Directions define error directions to be observed when calculating errors.

Scan Range values define the range where MC5P searches for the approximate actuation and deactuation point at the beginning of an automatic calibration of a switch. The range limits should be symmetrical in relation to the actuation/deactuation points.

11.11.2003 13:46			
<u>INSTRUMENT OUTPUT</u>			
Switch: Pressure [bar]			
Switch Type	Normally Closed		
Nominal Points			
Actuating	0.700000		
Deactuating	0.600000		
Error Calculation Directions			
Actuating	Up/Down		
Deactuating	Up/Down		
Scan Range			
Start Point	0.400000		
End Point	0.900000		
Save	Next page	Edit	MENU

Calibration Settings Page

The Setpoint Delay setting is of use only when the Calibration Method is set to Automatic. It defines how long MC5P waits before saving the input and output values after input value was changed to the next calibration point.

Maximum Allowed Calibration Point Deviation is a limit that defines how far the input signal value of the saved point can be from the theoretical calibration point. This setting is used both in manual and automatic calibration.

11.11.2003 13:47			
<u>CALIBRATION SETTINGS</u>			
Calibration Method	Automatic		
Calibration Points	5 ↑↓		
Setpoint Delay	5.00	s	
Maximum Allowed Calibration Point Deviation	< 0.00	%	
Calibration Repeats			
As Found	0		
As Left	1		
Cal. Period, Days	< 360		
Save	Next page	Edit	MENU

Again, the settings for a switch is somewhat different:

An additional Number of Repeats field is visible but no Calibration Points or Maximum Allowed Calibration Point Deviation fields.

Calibration Instructions Page

In addition to the actual instrument data, there are three note fields. **Starting Guide, Adjusting Guide and Finishing Guide.** They can be used to provide the calibrating technician with any kind of instructions that may be practical during the calibration procedure. The note texts may be written in MC5P or they can be downloaded from a calibration software. On this page, the three first rows of the note texts are shown, but when viewed during calibration each note may be as long as a full sized text window.

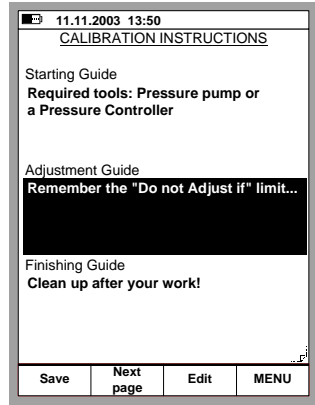

The fields on the Instructions Page need not be utilized, but if they include any text they will be shown at the appropriate stage of the calibration.

Deleting Instruments

If you want to free some memory or otherwise do not need certain instrument data anymore, you may remove instruments from MC5P's memory as follows:

To remove all instruments (and their calibration data), open the Position List and press D/Menu, 6/Delete All Instruments (see the leftmost picture below).

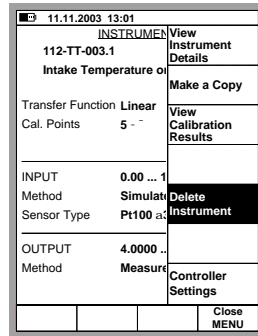
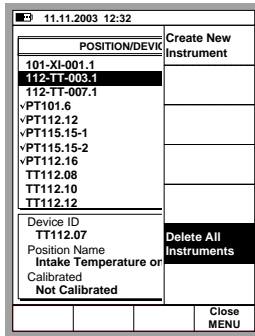

To remove a single instrument (and its calibration data), select it from the Position ID list. When viewing the instrument window, press D/Menu and 5/Delete Instrument (see the rightmost picture above).

Viewing Calibration Results

You can open the calibration result windows from two places:

When viewing the instrument window, press D/Menu and 3/View Calibration Results (see the leftmost picture below).

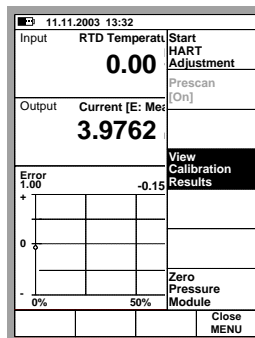
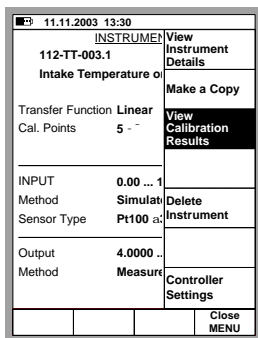

When viewing the calibration windows, and you haven't started a calibration run, press D/Menu and 2/View Calibration Results (see the rightmost picture above).

Calibration Result Windows

The results are displayed in table format and as a graph. There are also some additional data displaying the statistics of the calibration as well as environmental information that was automatically inserted during the calibration or it was manually entered after the calibration. If any calibration notes were written, they can also be seen on one of the calibration result pages. Use the B/Next Page, to change from one result page to another.

The table with numeric results may include more rows in the table than what can be displayed. Use the vertical cursor keys to scroll through all rows.

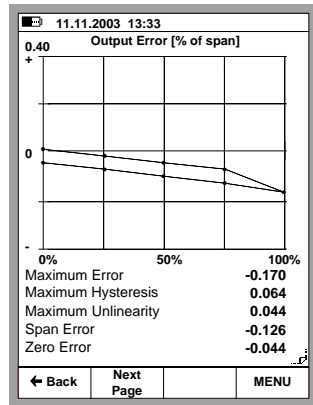

Input [°C]	Output [mA]	Error [%]
0.00	3.9930	-0.044
25.00	7.9890	-0.069
50.00	11.9834	-0.104
75.00	15.9777	-0.139
100.00	19.9729	-0.170
75.00	15.9875	-0.078
50.00	11.9925	-0.047
25.00	7.9979	-0.013
0.00	4.0032	0.020

How to Choose Which Calibration Run is Viewed

When viewing Calibration results, press D/MENU, 1/Calibration History. A list of saved calibrations is displayed. Select the calibration run to be viewed by moving the cursor (inverted text) to the desired calibration run and pressing either the **←** or the **g** key.

Deleting Calibration Results

When viewing Calibration results, press D/MENU.

To remove the current calibration run, press 3/Remove Results.

To remove all calibration results (for the current instrument), press 4/Remove All Results.

Appendixes

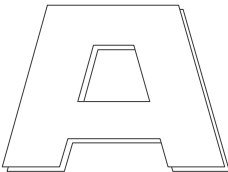
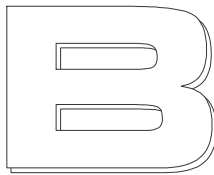
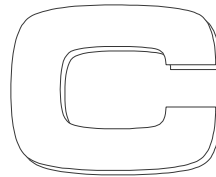
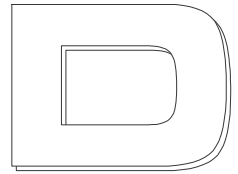

Appendix 1, User Guide for MC5 HART Option	132
Appendix 2, Technical Data	146
Appendix 3, Quick Guide for the MC5 Datalog Viewer	152
Appendix 4, Index	156

Appendix 1, User Guide for MC5P HART Option

Contents

General	133	HART and MC5P's Basic Mode	137
MC5P and HART	133	Connecting to a HART Instrument	137
HART Instruments and Beamex's Calibration Database Software	133	Disconnecting a HART Instrument	138
Connecting MC5P and a HART Instrument	134	Device Information	136
Supply From the Calibrator	134	Device Settings	137
External Supply	134	Trimming a HART Instrument in Basic Mode	139
Using MC5P as a HART Communicator	135	Adding a HART Instrument to MC5P's Instrument Database	141
Test Diode Connections	135	Calibrating a HART Instrument	142
HART Communication Settings	136	Selecting the Instrument to be Calibrated	142
		The Calibration Procedure	143
		Trimming a HART Instrument in Calibration Mode	143

General

HART (Highway Addressable Remote Transducer) is a digital communication protocol that uses sine waves superimposed on the standard 4 - 20 mA current. Because the HART signal is small, and its average value is zero it does not affect the accuracy of the analog current signal.

HART is a master-slave communication protocol, which means that during normal operation, each slave (field device) communication is initiated by a master communication device. Two masters (a primary master and a secondary master) can connect to a HART loop.

The HART communication protocol is an open standard owned by the member companies in the HART Communication Foundation (HCF). For additional information contact:

HART Communication Foundation,

9390 Research Boulevard, Suite I-350, Austin, Texas, 8759 USA.

Internet: <http://www.hartcomm.org>

MC5P and HART

MC5P Multifunction Calibrator's HART communication is a firmware option. The HART modem required for HART communication is located in the E module and the terminals of the E module are used for connecting MC5P with the Hart instrument.

MC5P supports HART Revision 5. Earlier revisions are not supported.

MC5P treats the Analog Output (AO) and the Digital Output (PV, Primary Variable) as separate instruments. To calibrate/trim both output signals, an Analog Output instrument and a Digital Output instrument need to be created into MC5P's instrument database. This can be done manually or automatically by communicating with the HART instrument to be calibrated/trimmed.

HART Instruments and Beamex's Calibration Database Software

Beamex's QCAL[®] Calibration Database Software support HART instruments as follows:

CMX Calibration Maintenance management software. All versions.

QM6 Quality Manager starting from version 1.90/1.90a.

QD3 Quality Documenter starting from version 2.10.

Connecting MC5P and a HART Instrument

How the HART instrument is connected to MC5P depends on the supply power connection and whether there is a test diode connected to the transmitter. The following pictures describe the connections for each case.

Supply From the Calibrator

MC5P supplies the transmitter and measures the output current. The HART® terminal is used for digital communication. MC5P automatically includes the required 270 ohm resistor.

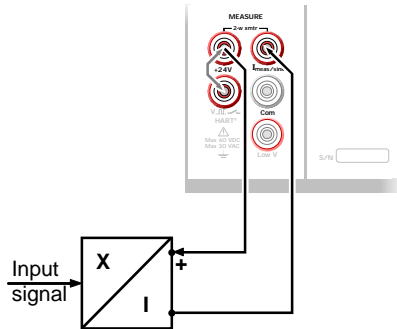

External Supply

MC5P measures the externally supplied output current of the transmitter. The HART® terminal is used for digital communication. Remember to make sure that the loop also includes a resistor with a resistance between 230 to 600 ohm or that the impedance of the loop itself is at least 230 ohms.

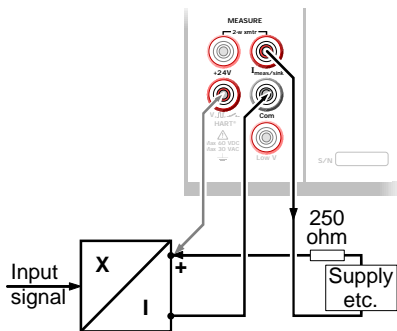

Using MC5P as a Hart Communicator

If you want to use MC5P as a Hart communicator without measuring/controlling the instrument's output current, connect MC5P as shown in the adjacent picture. Again, make sure that there is a resistor (or enough resistance) in the loop to enable Hart communication.

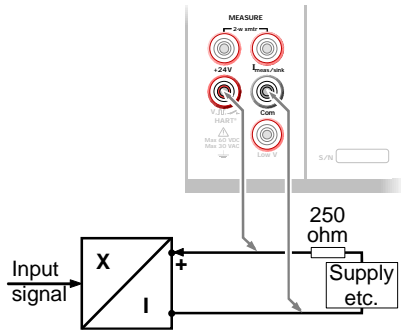

Test Diode Connections

MC5P also supports HART® communication while measuring current parallel to a test diode in a 20 mA circuit. The external connections vary depending on the diode connection of the transmitter:

Plus Side Test Diode

Minus Side Test Diode

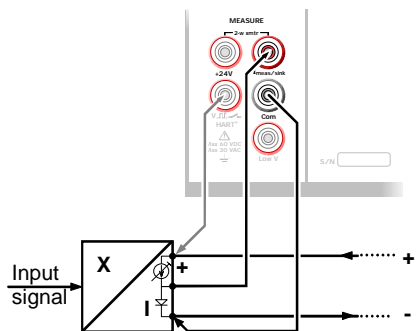
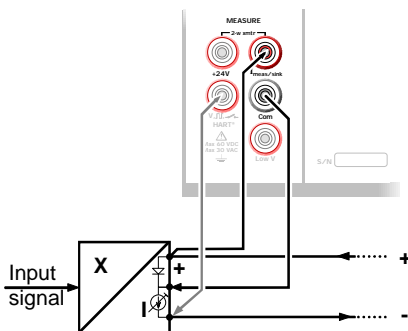

HART Communication Settings

Before attempting to communicate with HART instruments it is advisable to review MC5P's HART communication settings. Open the settings window by pressing

- D/Menu,
- C/Others and
- 3/HART Communication Settings

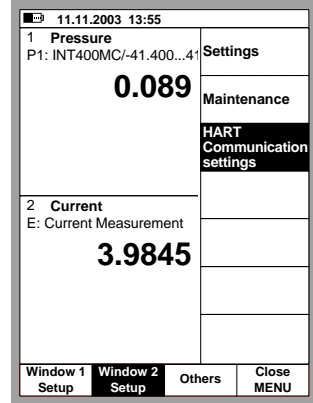

Master Address

HART communication supports the use of two masters, a Primary and a Secondary master. Select a unique master address for MC5P.

Preambles used

Can be a value between 3 to 20. The smaller the value is, the faster the communication is, but instruments requiring a larger amount of preambles may not communicate.

Number of Retries

Can be a value between 1 to 10. Determines the amount of retries when communication errors occur.

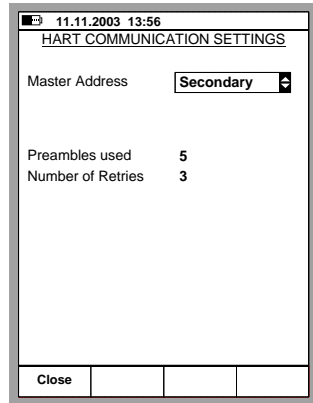

HART and MC5P's Basic Mode

Connecting to a HART Instrument

To communicate with a HART instrument, press:

D/Menu and

B/Window 2 Setup, if needed

5/HART.

Note.



The HART menu option is disabled if the other window already reserves the E module. Change the setup of the other window to enable the HART menu option.

11.11.2003 13:57	
1 Pressure P1: INT400MC/-41.400...4	Quantity [Current] 0.089 Function/Port [E:!(Meas)] Step, Ramp Unit [mA] HART
2 Current E: Current Measurement	3.9855
Window 1 Setup	Window 2 Setup Others Close MENU

Refer to chapter **Connecting MC5P and a HART Instrument** on page 134 for information on how to connect MC5P and a HART instrument.

MC5P searches for HART devices connected to the current loop and opens a window similar to the one seen to the right.

Up to 16 instruments may be connected to the same current loop.

Choose the appropriate instrument by pressing 4/Select (optionally either the  or the  key).

11.11.2003 13:58	
HART	
Searching for HART Device at: 12	
Devices found:	
0 - 3051 - PRESS TRANSM	
1 - PT155 - NC TTR	
2 - PT311 - ARG JT	
3 - PT413 - WBA4 NTB	
4 - TT210 - PLGR NSWF	
5 - TT921 - FPN ILL	
6 - TT148 - TBB NE	
← Back	Restart Select

Note.

Measuring the Analog Output (AO) of a HART instrument does not require any special actions. Just connect the Analog Output to MC5P's current measurement terminals in the E module.

The standard Window Setup menu is replaced by a HART menu. This menu is automatically opened after the HART instrument is selected. All HART menu options are described in the subsequent chapters. The measurement quantity of the window where the HART instrument was selected to is automatically changed to the quantity of the HART instrument's Digital Output (PV).

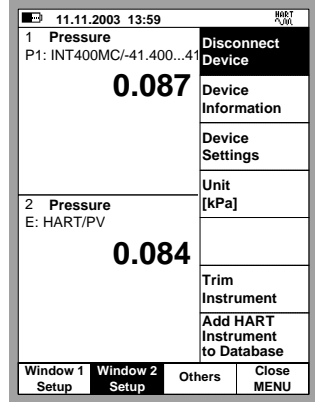

Disconnecting a HART Instrument

The HART instrument is to be disconnected when you need to change the Quantity of a window assigned for HART measurement.

To disconnect a HART instrument, select D/Menu and B/Window 2 Setup, if needed 1/Disconnect Device.

The HART communication is terminated and the HART menu is replaced by the standard Window Setup menu.

Device Information

The adjacent picture displays the data of the Device Info window. The following fields are editable:

- Tag,
- Serial Number,
- Date,
- Descriptor and
- Message.

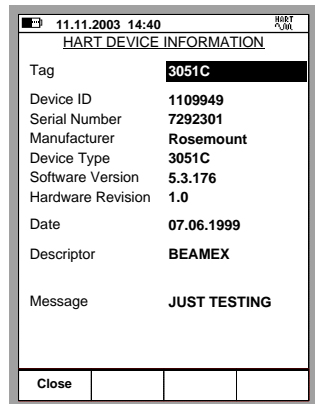

Device Settings

The adjacent picture displays the data of the Device Settings window. The following fields are editable:

Tag,
Polling Address,
PV/Range Unit,
Lower Range,
Upper Range,
Damping,
Transfer Function,
Burst Mode and
Sensor Serial Number.

11.11.2003 14:41		HART V00
DEVICE SETTINGS		
Tag	3051C	
Polling Address	0	
Output		
PV/Range Unit	mbar	
Lower Range	0.00	
Upper Range	1000.00	
Damping (s)	0.40	
Transfer Function	Linear	
Burst Mode	Off	
Sensor		
Serial Number	1109949	
Lower Limit	0.00	
Upper Limit	2486.41	
Minimum Span	24.87	
Close		

Trimming a HART Instrument in Basic Mode

Note that MC5P's Calibration Mode also includes a possibility to trim HART instruments. Trimming a HART Instrument in Basic Mode is only needed when you do not intend to **calibrate and trim** the HART instrument.

To start trimming the HART instrument, press:

D/Menu and
B/Window 2 Setup, if needed
6/Trim Instrument.

From the pop-up list, select which output, analog or digital, is to be trimmed. MC5P reads the instrument data while displaying the following message:

Reading HART instrument data.
Please wait.

11.11.2003 14:42		HART V00
1	Pressure P1: INT400MC/-41.400...41	Disconnect Device
	0.088	Device Information
		Device Settings
		Unit [kPa]
2	Pressure E: HART/PV	
	0.084	
	Analog Output (AO) Digital Output (PV)	Trim Instrument
		Add HART Instrument to Database
Close		

For the Digital Output (PV), MC5P opens the Instrument Input Window for checking/editing the settings. Use B/Next Page Function Key to check/edit the Instrument Output Window data.

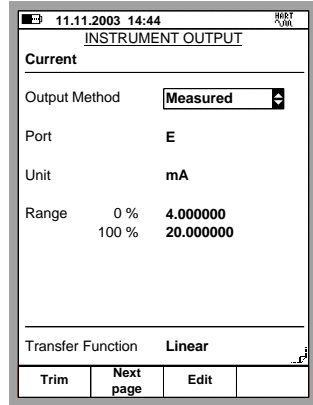
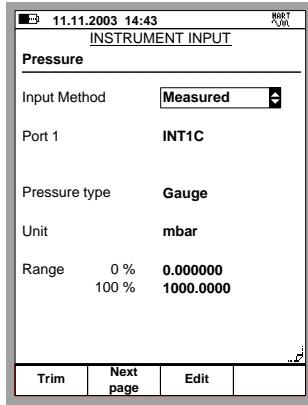

Selecting the A/Trim Function Key opens the Calibration Windows with the HART instrument's trim menu opened. To change to Analog Output (AO), use the menu option 4/Select Output.

Warning!
Do not alter any settings unless you have the knowledge and are authorized to trim the HART instrument.

Note.

Some of the menu options may be disabled when trimming certain HART instruments. Refer to the HART instrument's manual for device dependent information concerning the trimming procedure.

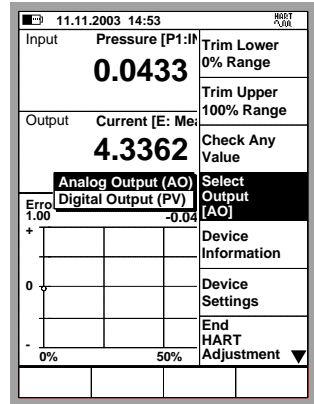

Adding a HART Instrument to MC5P's Instrument Database

MC5P has a semi-automatic utility to add HART instruments to MC5P's instrument database. Select 7/Add HART instrument to Database from the Basic Mode's HART Menu. Continue by selecting which output is to be added, analog or digital.

The following instrument data is acquired from the HART instrument:

Input Quantity	Input Unit
Input Range	Input Method
Output Quantity	Output Unit
Output Range	Output Method
Transfer Function	Device ID
Setpoint Delay	

When the instrument is created, MC5P automatically opens the Instrument Window, from where it is easy to either check/edit instrument data or start calibrating the instrument. It is recommended to edit the instrument data and carefully check the default values assigned for instrument data fields that do not have corresponding fields in HART instrument data. To edit the instrument data, press the 2/Edit button.

At least the following instrument data fields should be checked:

Error Calculation Method	Reject if >	Input Port
Calibration Method	Calibration Points	Output Port

Keep in mind that changing the value of some of the above mentioned fields may also require changes in related fields.

Notes.

The HART instrument's TAG is assigned to the Device ID field in MC5P. No Position ID is automatically assigned to the instrument.

CMX Calibration Maintenance management software as well as **QM6 Quality Manager** version 1.90a and later support adding instruments created in MC5P to QM6's database. **QD3 Quality Documenter** cannot receive instrument data from MC5P. It can receive only calibration results of instruments already existing in QD3's database.

11.11.2003 14:47		HART NOV
1 Pressure P1: INT400MC/-41.400...41	1.1	Disconnect Device
		Device Information
		Device Settings
		Unit [mbar]
2 Pressure E: HART/PV	1.142	Trim Instrument
		Add HART Instrument to Database
Analog Output (AO) Digital Output (PV)		
Window 1 Setup	Window 2 Setup	Others Close MENU

11.11.2003 14:48		HART NOV
INSTRUMENT		
JUST TESTING		
Transfer Function	Linear	
Cal. Points	3 -	
INPUT	0.00 ... 1000.00 mbar	
Method	Measured	
Pressure Type	Gauge	
OUTPUT	4.0000 ... 20.0000 mA	
Method	Measured	
← Back	Edit	Calibrate MENU

Calibrating a HART Instrument

Selecting the Instrument to be Calibrated

To be able to calibrate the HART instrument, it has to be added to MC5P's instrument database. The analog output (AO) and the digital output (PV) are treated as separate instruments.

Adding the instruments can be done using the utility described in chapter **Adding a HART Instrument to MC5P's Instrument Database** on page 141 or by sending the instrument data from a calibration software. Additionally: you can also manually enter the instrument data into MC5P's instrument database.

Select the instrument to be calibrated from MC5P's list of available instruments.

If you are already connected to the HART instrument (HART communication started in Basic Mode), MC5P continues directly from the Instrument Window to the Calibration Windows.

If HART communication is not started and you are calibrating the digital output (PV) of the HART instrument, MC5P prompts you to start the communication and select the instrument in a window similar to the adjacent picture.

MC5P accepts the HART instrument as the instrument to be calibrated only if its instrument data matches with the data of the instrument selected in MC5P.

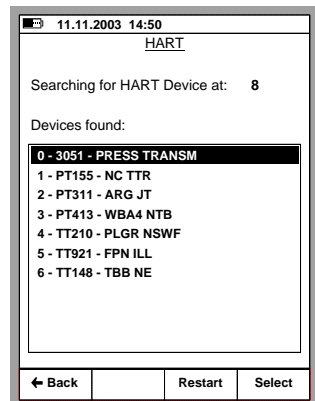
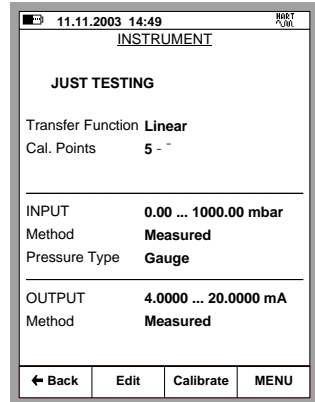

The Calibration Procedure

Calibrating a HART instrument does not differ from the calibration of a non-HART instrument with similar input quantity, input method, output quantity and output method. Refer to the examples in MC5P User Guide's Part D.

Note.

Calibrating the Analog Output (AO) of a HART instrument does not necessarily require HART communication. MC5P treats it as a standard analog instrument during the calibration procedure.

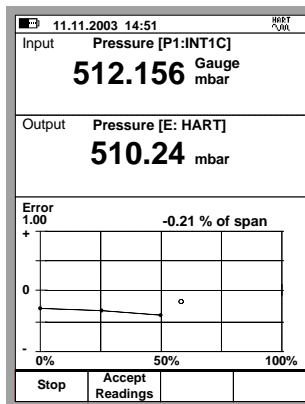

Trimming a HART Instrument in Calibration Mode

There is a special utility for trimming a HART instrument during calibration. To start the HART adjustment, select D/MENU and 1/Start HART Adjustment.

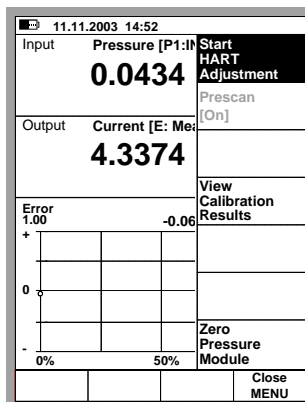

How MC5P continues depends on the instrument previously selected for calibration:

- If the output signal of the previously selected instrument is the digital output of a HART instrument, the instrument input data window, shown as the leftmost picture below is opened immediately.
- For all other output signals MC5P prompts you to start the communication and select the instrument to be calibrated (refer to the picture in chapter **Selecting the Instrument to be Calibrated** on page 142. Then the instrument input data window shown below is opened.

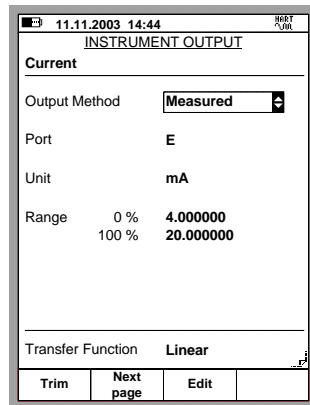
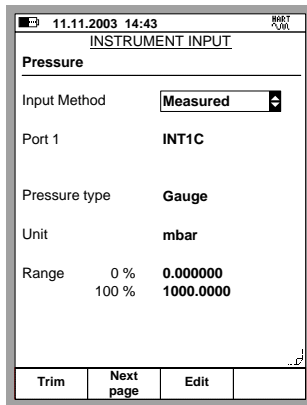

Press B/Next Page Function Key to check/edit instrument output data and then A/Trim to start the adjustment.

MC5P opens the HART Adjustment menu with the Digital Output (PV) selected. To change to Analog Output (AO), use the menu option 4/Select Output.

Warning!

Do not alter any settings unless you have the knowledge and are authorized to trim the HART instrument.

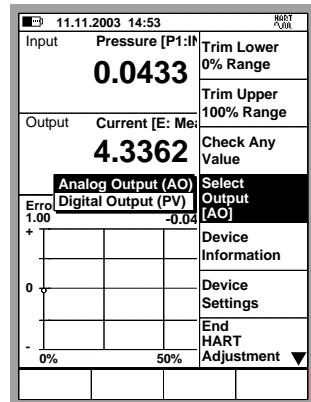

When trimming the **Digital Output** (PV), the Input window displays the instrument's input signal measured by MC5P. The Output window displays the digital output of the instrument.

The lower part of the Output window includes an additional trim field. Use either the C/Fetch Function Key to copy the value shown in the input window or manually enter a value the digital output should be trimmed to. Then use the D/Send Function Key.

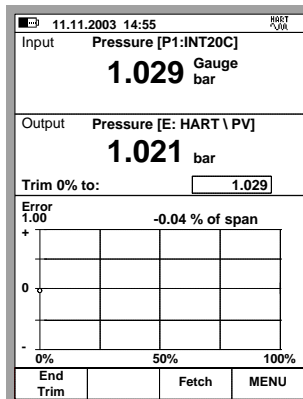

When trimming the **Analog Output** (AO), the Input window displays the current set point communicated by MC5P. The Output window displays the current generated by the instrument and measured by MC5P.

Again, the lower part of the Output window includes an additional field. Use either the C/Fetch Function Key to copy the value shown in the Output window or manually enter a value that is the correct output current. Then use the D/Send Function Key.

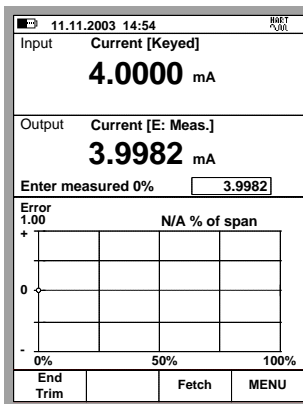

Note.

Some of the menu options may be disabled when trimming certain HART instruments. Refer to the HART instrument's manual for device dependent information concerning the trimming procedure.

Appendix 2, Technical Data

Contents

MC5P General Specifications	147
Modules	148
Pressure Modules (INT & EXT)	148
Temperature Electrical Module (ET) ...	149
RTD Measurement and Simulation	149
Thermocouple Measurement and Simulation	150
Reference Junction Module (RJ)	150
Electrical Module (E)	151

MC5P General Specifications

General	
Display	96 x 72 mm (3.78" x 2.83"), 320 x 240 pixels, back lit LCD
Weight	<ul style="list-style-type: none"> - Base Unit and E module: 2.65 kg (approx. 5.9 lb) - ET Module: 1.40 kg (approx. 3.1 lb) - Internal Pressure Modules: 0.65 kg each (approx. 1.5 lb)
Dimensions*	<ul style="list-style-type: none"> - Base Unit and E module: <ul style="list-style-type: none"> width: 214 mm (approx. 8½") height: 178 mm (approx. 7") depth: 240 mm (approx. 9½") - ET Module: <ul style="list-style-type: none"> width: 107 mm (approx. 4¼") height: 178 mm (approx. 7") depth: 241 mm (approx. 9½") - Internal Pressure Modules: <ul style="list-style-type: none"> width: 53.5 mm (approx. 2¹/₈") height: 178 mm (approx. 7") depth: 152 mm (approx. 6")
Keyboard	Membrane protected individual keys
Supply voltage	100...240 VAC, 50-60 Hz
Operating temperature	-10...50°C (14...122°F)
Specifications valid	15...35°C (59...95°F)
Temperature coefficient	< ±0.001% RDG / °C outside of 15...35°C (59...95°F)
Storage temperature	-20 to 60°C (-4 to 140°F)
Humidity	0 to 80% R.H. non condensing
Measurement sample rate	2.5 / second
Warranty for MC5P	3 years as standard

* Module width is the width of the front panel
Module height is the height of the front panel (possible extension plates not included)
Module depth includes standard connectors installed on the front panel.

Modules

Pressure Modules (PM & EXT)

Internal Modules	External Modules	Unit	Range ^{1,2}	Resolution	90 Days Uncertainty ¹ (±)	1 Year Uncertainty ¹ (±)
PM B	EXT B	kPa a	80 to 120	0.01	-	0.05 kPa
		mbar a	800 to 1200	0.1	-	0.5 mbar
		psi a	11.6 to 17.4	0.001	-	0.0073 psi
PM100m	EXT100m	kPa	0 to 10	0.0001	0.025% RDG + 0.025% FS	0.04% RDG + 0.025% FS
		mbar	0 to 100	0.001		
		iwc	0 to 40	0.001		
PM400mC	EXT400mC	kPa	-40 to 40	0.001	0.025% RDG + 0.02% FS	0.04% RDG + 0.02% FS
		mbar	-400 to 400	0.01		
		iwc	-160 to 160	0.001		
PM1C	EXT1C	kPa	-100 to 100	0.001	0.025% RDG + 0.01% FS	0.04% RDG + 0.01% FS
		bar	-1 to 1	0.00001		
		psi	-14.5 to 15	0.0001		
PM2C	EXT2C	kPa	-100 to 200	0.001	0.025% RDG + 0.01% FS	0.04% RDG + 0.01% FS
		bar	-1 to 2	0.00001		
		psi	-14.5 to 30	0.0001		
PM6C	EXT6C	kPa	-100 to 600	0.01	0.025% RDG + 0.01% FS	0.04% RDG + 0.01% FS
		bar	-1 to 6	0.0001		
		psi	-14.5 to 90	0.001		
PM20C	EXT20C	kPa	-100 to 2000	0.01	0.025% RDG + 0.01% FS	0.04% RDG + 0.01% FS
		bar	-1 to 20	0.0001		
		psi	-14.5 to 300	0.001		
PM60	EXT60	kPa	0 to 6000	0.1	-	0.04% RDG + 0.01% FS
		bar	0 to 60	0.001	-	
		psi	0 to 900	0.01	-	
PM100	EXT100	MPa	0 to 10	0.0001	-	0.04% RDG + 0.01% FS
		bar	0 to 100	0.001	-	
		psi	0 to 1500	0.01	-	
PM160	EXT160	MPa	0 to 16	0.0001	-	0.04% RDG + 0.013% FS
		bar	0 to 160	0.001	-	
		psi	0 to 2400	0.01	-	
PM250	EXT250	MPa	0 to 25	0.001	-	0.04% RDG + 0.015% FS
		bar	0 to 250	0.01	-	
		psi	0 to 3700	0.1	-	
PM600	EXT600	MPa	0 to 60	0.001	-	0.04% RDG + 0.015% FS
		bar	0 to 600	0.01	-	
		psi	0 to 9000	0.1	-	
-	EXT1000	MPa	0 to 100	0.001	-	0.04% RDG + 0.015% FS
		bar	0 to 1000	0.01	-	
		psi	0 to 15000	0.1	-	

¹) Uncertainty includes reference standard uncertainty, hysteresis, non-linearity, repeatability and typical long term stability for mentioned period. (k=2)

²) Every internal/external pressure module's range may be displayed also in absolute pressure if the Barometric Module (PM B) is installed.

Supports the following pressure units as standard: Pa, hPa, kPa, MPa, mbar, bar, lbf/ft², psi, gf/cm², kgf/cm², kgf/m², kp/cm², at, mmH₂O, cmH₂O, mH₂O, iwc, ftH₂O, mmHg, cmHg, mHg, inHg, mmHg(0°C), inHg(0°C), mmH₂O(4°C), inH₂O(4°C), inH₂O(60°F), mmH₂O(68°F), inH₂O(68°F), ftH₂O(68°F), torr, atm.

Pressure modules 20 bar and below, pressure connection G 1/8 (ISO 228/1) 60° internal cone.

PM60, PM100, PM160 module pressure connection G 1/8 (ISO 228/1) female.

EXT60, EXT100, EXT160, EXT250, EXT600, EXT1000 pressure module pressure connection G 1/4 (ISO 228/1) male.

Wetted parts AISI316 stainless steel, Hastelloy, Nitrile rubber.

In the PM20C, EXT20C, PM60, EXT60, PM100, EXT100, PM160, EXT160, PM250 and EXT250 the maximum overpressure is twice the range. The maximum overpressure for PM600 and EXT600 is 900 bar and for EXT1000 1100 bar.

Temperature Electrical Module (ET)

Function	Range	Resolution	1 Year Uncertainty ¹
mV generation ²	± 500 mV	0.001 - 0.01 mV	0.02 % RDG + 4 µV
V generation ³	± 12 V	0.00001 - 0.0001 V	0.02 % RDG + 0.1 mV
mA generation ⁴	± 25 mA	0.0001 mA	0.02 % RDG + 1 µA
Hz generation ⁵	0.00028 to 50000 Hz	0.000001 - 0.1 Hz	0.01 % RDG
Pulse generation ⁶	0 to 9 999 999 pulses	1 pulse	N/A
Ohm simulation ⁷	1 to 4000 ohm	0.01 - 0.1 ohm	0.04 % RDG or 30 mohm ⁸
Ohm measurement ⁹	0 to 4000 ohm	0.001 - 0.1 ohm	0.02 % RDG + 3.5 mohm
mV measurement ¹⁰	± 500 mV	0.001 - 0.01 mV	0.02 % RDG + 4 µV

¹ Uncertainty includes reference standard uncertainty, hysteresis, nonlinearity, repeatability and typical long term stability for mentioned period. (k=2)

² Load effect < 5 µV/mA. Maximum output current 5 mA.

³ Load effect < 100 µV/mA. Maximum output current 10 mA (0 ... 10 V), 3 mA (10 ... 12 V).

⁴ Maximum load impedance 400 ohm.

⁵ Amplitude range 0 ... 12 Vpp. Amplitude setting accuracy up to 5 kHz ±(200 mV + 5% of set value). Waveforms: Square wave (positive / symmetric) and sinewave (above 40 Hz).

⁶ Pulse generation frequency range 0.1 ... 1000 Hz. Amplitude setting 0 ... 12 Vpp.

⁷ Valid with measurement current 0.2 ... 5 mA (1 ... 1000 ohm), 0.1 ... 1mA (1 ... 4 kohm). Ohm/RTD simulation speed 1 ms.

⁸ Whichever is greater.

⁹ Specification valid with 4 wire connection. In 3 wire connection add 10 mohm.

¹⁰ Bias current < 10 nA.

RTD Measurement and Simulation

Function	Range (°C)	Range (°C)	Measurement 1 Year Uncertainty ¹ (±)	Simulation 1 Year Uncertainty ¹ (±)
Pt-sensors	-200 to 850°C	-200 to 0°C 0 to 850°C	0.06°C 0.025% RDG + 0.06°C	0.1°C 0.025% RDG + 0.1°C

¹ Uncertainty includes reference standard uncertainty, hysteresis, nonlinearity, repeatability and typical long term stability for mentioned period. (k=2).

RTD types available as standard:

- Pt50 (385)
- Ni100 (618)
- Pt100 (3923)
- Pt100 (375)
- Pt400 (385)
- Pt500 (385)
- Pt100 (385)
- Ni120 (672)
- Pt100 (3926)
- Pt100 (389)
- Pt100 (391)
- Pt1000 (385)
- Pt200 (385)
- Cu10 (427)

RTD/ohm simulation excitation current 0.2 ... 5 mA (1 ... 1000 ohm), 0.1 ... 1 mA (1 ... 4 kohm).
Also other RTD types available as option

Thermocouple Measurement and Simulation

Type	Range (°C)	Range (°C)	1 Year Uncertainty ⁽¹⁾ (±)
B ⁽²⁾	0 ... 1820	0 ... 200	⁽³⁾
		200 ... 500	2.0 °C
		500 ... 800	0.8 °C
		800 ... 1820	0.6 °C
R ⁽²⁾	-50 ... 1768	-50 ... 0	1.0 °C
		0 ... 150	0.7 °C
		150 ... 1400	0.5 °C
		1400 ... 1768	0.6 °C
S ⁽²⁾	-50 ... 1768	-50 ... 0	1.0 °C
		0 ... 50	0.7 °C
		50 ... 1500	0.6 °C
		1500 ... 1768	0.7 °C
E ⁽²⁾	-270 ... 1000	-270 ... -200	⁽³⁾
		-200 ... 0	0.08 % RDG + 0.07°C
		0 ... 600	0.015 % RDG + 0.07°C
		600 ... 1000	0.026 % RDG
J ⁽²⁾	-210 ... 1200	-210 ... -200	⁽³⁾
		-200 ... 0	0.07 % RDG + 0.08°C
		0 ... 1200	0.02 % RDG + 0.08°C
K ⁽²⁾	-270 ... 1372	-270 ... -200	⁽³⁾
		-200 ... 0	0.1 % RDG + 0.1 °C
		0 ... 1000	0.02 % RDG + 0.1 °C
		1000 ... 1372	0.03 % RDG
N ⁽²⁾	-270 ... 1300	-270 ... -200	⁽³⁾
		-200 ... -100	0.2 % RDG
		-100 ... 0	0.05 % RDG + 0.15°C
		0 ... 750	0.01 % RDG + 0.15°C
		750 ... 1300	0.03 % RDG
T ⁽²⁾	-270 ... 400	-270 ... -250	⁽³⁾
		-250 ... -200	0.7 °C
		-200 ... 0	0.1 % RDG + 0.1°C
		0 ... 400	0.01 % RDG + 0.1°C
U ⁽⁴⁾	-200 ... 600	-200 ... 0	0.1 % RDG + 0.15°C
		0 ... 600	0.01 % RDG + 0.15°C
		0 ... 900	0.07 % RDG + 0.13°C
L ⁽⁴⁾	-200 ... 900	-200 ... 0	0.07 % RDG + 0.13°C
		0 ... 900	0.02 % RDG + 0.13°C

Resolution 0.01°C.

With internal reference junction (module RJ) add 0.1°C uncertainty.

Thermocouple types C 3) (ASTM E 988 - 96), G 3) (ASTM E 1751 - 95e1) and D 3) (ASTM E 988 - 96) also available as standard. Also other thermocouple types available as option.

¹⁾ Uncertainty includes reference standard uncertainty, hysteresis, nonlinearity, repeatability and typical long term stability for mentioned period. (k=2)

²⁾ IEC 584, NIST MN 175, BS 4937, ANSI MC96.1

³⁾ ±0.02 % of thermovoltage + 4 µV

⁴⁾ DIN 43710

Reference Junction Module (RJ)

Range (°C)	1 Year Uncertainty ⁽¹⁾ (±)
-10 ... 50 °C	0.1 °C

¹⁾ Uncertainty includes reference standard uncertainty, hysteresis, nonlinearity, repeatability and typical long term stability for mentioned period. (k=2)

Electrical Module (E)

Function	Range	Resolution	1 Year Uncertainty ¹
mV measurement ⁽²⁾	±1000 mV	0.001 - 0.01 mV	0.02 % RDG + 5 µV
V measurement ⁽³⁾	±50 V	0.00001 - 0.001 V	0.02 % RDG + 0.25 mV
mA measurement ⁽⁴⁾	±100 mA	0.0001 - 0.001 mA	0.02 % RDG + 1.5 µA
Hz measurement ⁽⁵⁾	0.0028 to 50000 Hz	0.000001 - 0.1 Hz	0.01 % RDG
Pulse counting ⁽⁵⁾	0 to 9 999 999 pulses	1 pulse	N/A
mA generation ⁽⁶⁾	0 to 25 mA	0.0001 mA	0.02 % RDG + 1.5 µA

¹⁾ Uncertainty includes reference standard uncertainty, hysteresis, nonlinearity, repeatability and typical long term stability for mentioned period. (k=2)

²⁾ Bias current <10 nA

³⁾ Impedance >1 Mohm

⁴⁾ Impedance < 7.5 ohm

⁵⁾ Impedance > 1 Mohm. Frequency measurement minimum amplitude 0.5 Vpp (< 5 kHz),
1 Vpp (5...50 kHz). Pulse counting minimum amplitude 0.5 Vpp (pulse length > 100 µs),
1 Vpp (pulse length 100 µs...10 µs).
Trigger level range -1...+15 V.

⁶⁾ Maximum load impedance 800 ohm

All specifications are subject to change without prior notice

Appendix 3, Quick Guide for the MC5 Datalog Viewer

Contents

MC5 Datalog Viewer	153
General	153
Installing MC5 Datalog Viewer	153
Communication Settings	153
File Management	153
Transferring data from MC5P	153
Saving Data on Hard Disk	154
Opening Existing Data Files	154
Importing and Exporting	154
Other Utilities	154
Chart Properties	154
Channel Properties	155
Zooming	155
Printing the Graph	155

MC5 Datalog Viewer

General

MC5 Datalog Viewer is a utility for transferring Data Logging results from MC series calibrators to a personal computer (PC). The results can be viewed in MC5 Datalog Viewer and saved in the utility's own format or exported for use in other applications, e.g. Microsoft Excel®.

MC5 Datalog Viewer has two windows. One for displaying the results in a table and another that displays a graph based on the results.

The graph and the table have a linked cursor. Double-click anywhere inside the graph area and you will see a vertical bar. The corresponding data row in the table is highlighted. Similarly, if you move the highlighted row in the table (by clicking on another row or using the arrow keys), the vertical bar in the graph window moves to the corresponding location in the graph.

Installing MC5 Datalog Viewer

MC5 Datalog Viewer does not require a special installation procedure. Just copy **MC5_DataLog.exe** to a folder that suits your needs and start the software from that location.

Communication Settings

Before connecting to MC5P Multifunction Calibrator, be sure to select the correct **Serial Port** and **Port Speed** in the settings menu.

Always start using the maximum Port Speed. If communication problems arise, decrease the port speed.

File Management

Transferring data from MC5P

To upload the results, select the **Transfer Data** button in the toolbar. In the following dialog: Select the data to be downloaded and press **Start**.

The data is uploaded to the RAM memory of the PC and is available for viewing in MC5 Datalog Viewer.

Saving Data on Hard Disk

When saving using the **Save** or **Save As** commands, MC5 Datalog Viewer saves the results in its own format (*.lg5). This file format preserves all the changes in the property settings described in chapters **Chart Properties** and **Channel Properties**.

Opening Existing Data Files

Selecting the **Open** icon in the toolbar (or Open in the File menu) opens files in software's own format (*.lg5). To read data saved in other supported formats, choose the Import option in the File menu.

Importing and Exporting

MC5 Datalog Viewer supports importing and exporting of Worksheet files (*.csv) and text Files (*.txt). Both file formats are also supported by several spreadsheet software, e.g. Microsoft Excel®. When exporting, MC5 Datalog Viewer gives you the possibility to select the CSV file separator (comma or a list separator based on Window's settings).

Other Utilities

All of the property settings described in the subsequent chapters are preserved only when saving data in MC5 Datalog Viewer's own file format (*.lg5). Other file formats (*.csv and *.txt) save only the data, but no property settings.

Chart Properties

Select **Chart Properties** in the toolbar to edit the following settings:

Tab	Property	Description
General	Series Visibility	Each data channel can be made visible/invisible. Making a data channel invisible is also possible through the Channel Property settings, but this is the only place to make a channel visible again after it has been set to "invisible".
	Animated Zoom	Adds/removes animation effects when zooming in. More information in chapter Zooming .
Axis	Axis	First select the Axis to be defined.
	- Autoscaling	When selected, the axis minimum and maximum is automatically determined.
	- Min	Axis minimum value. Editable only when autoscaling is not selected.
	- Max	Axis maximum value. Editable only when autoscaling is not selected.
	- Axis Number Format	The number format used for the selected axis. Supported formats are listed at the end of MC5 Datalog Viewer's help file
	- Title	Enter a title for the selected axis.

Tab	Property	Description
Paging	Paging ON/OFF	If paging is selected, the graph is divided into several horizontal "pages".
	- Points per Page	How many points is displayed per page.
	- Current Page	A possibility to jump to a certain page. When paging is selected, you can also scroll from page to page as well as to the first and last page using the arrow icons displayed in the lower left corner of the graph window.
Title	Title Visible	Whether a title is visible or not.
	- Title text	The title text to be shown in the graph.

Channel Properties

The property setting window for each channel can be opened clicking on the line in the graph legend.

The following settings are available:

Property	Description
Axis control	The channel can be assigned either to the left or the right axis. By default all channels are assigned to the left axis.
Line color	Here you can change the color of the line if the default color does not suit your needs.
Line width	A possibility to change the line width. The default width is 2.
Series name	Give the Channel a more descriptive name.

Zooming

To zoom in, drag you mouse from the upper left corner to the lower right corner of the area to be zoomed in to. The important thing is that your mouse moves **from left to right**.

You can scroll the zoomed area by selecting the secondary button and dragging desired direction.

To zoom back to the original size, drag your mouse **from right to left** with a slight upward or downward movement.

Printing the Graph

To print the graph, select the **Print Chart** option from the toolbar button or use the option in the File menu. A standard print dialog appears for choosing the printer.

Appendix 4, Index

2

2-wire system 98

3

3-wire system 97

4

4-wire system 97

A

Acknowledging alarms 70

Adding Instruments 124

Adjustment 104, 123

Advanced Utilities

Environment temperature sensor 75

Alarms

Acknowledging 70

Volume setting 73

As Found calibration 104

As Left calibration 105

Autocapture Feature 113

Automatic calibration 112

Auto-Off Delay 73

B

Base Unit 5

Basic Mode, defined 31

Binary Signal Detection 41

Brightness of the display 5

C

Calibration

Adjustment 104

As Found 104

As Left 105

Autocapture Feature 113

Automatic 112

Deleting the results 131

Examples 113

Generally 102

Instrument

adjustment 123

Instrument Window 109

Maintaining the Instrument

Database 124

Manual 112

Phases 103

Procedure, defined 110

Required modules 106

Saving the results 111

Selecting the

Instrument 108

Calibration Method field
112, 122, 128

Calibration Results

Deleting 131

Viewing 130

Calibrator configuration,
see Settings 72

Certifications and Compli-
ances 22

Change Rate 50

Charger 26

Cleaning MC5P 27

Compensation loop 98

Computer Interface 7

Configuring the Calibrator,
see Settings 72

Connectable devices 21

Connections 4

AUX Interface 8

COMP/PRT Interface 7

ENV Interface 7

External pressure

modules 7

Internal pressure

modules 7

Contrast of the display 5

Copying an instrument
125

Creating Instruments 124

Current generation 56

Current measurement 37

D

Data Logging

Configuring 82

Starting 83

Transferring data to a PC
84

Viewing Results 84

Deleting Instruments 129

Deviation measurement 51

Difference measurement
52

Display

Brightness 5

Contrast 5

Display Mode 76

Error Display 78

Percentage 78

Scaling 77

E

- EC Declaration of Conformity** 22
- Editing fields** 17
- Electrical and Temperature module (ET)** 6
- Electrical limit switch calibration** 120
- Electrical module (E)** 5
- Environment temperature sensor** 7, 75
- Error Display** 78
- Error situations in thermo-couple measurement** 96
- Examples of Instrument Calibration** 113
- External devices** 21
- External Devices** 8, 85, 122
 - Calibration Mode 114
 - DPI510 87
 - POC4 87
 - TekKnow 88
 - Use in Basic Mode 86
- External pressure modules** 7
- External Reference Junction** 94

F

- Filtering** 51
- Fine Tuning** 55
- Firmware**
 - Basic Mode 12
 - Editing fields 17
 - Function Keys 15
 - General description 11
 - Help function 13
 - Menus 15
 - Status bar 14
 - Updating 11
 - User Interface 14
- Frequency generation** 60
- Frequency measurement** 44
- Function Keys** 15

G

- Generating (see also Simulating)**
 - Changing the generated signal 55
 - Current 56
 - Fine Tuning 55
 - Frequencies 60
 - General description 54
 - Pulses 61
 - Using the E module 56
 - Using the ET module 56, 58, 60, 61
 - Voltagess 58

H

- Help function** 13

I

- Input Method field** 122, 126
- Instrument adjustment support** 123
- Instrument Database** 124
 - Calibration Instructions Page 129
 - Calibration Settings Page 128
 - Deleting Instruments 129
 - General Data Page 126
 - Instrument Input Page 126
 - Instrument Output Page 127
- Instrument Window** 109
- Internal pressure modules** 7
- Internal Reference Junction** 93

K

- Keyboard, defined** 9

L

- Limit Switch test** 42
- Line Frequency** 73

M

- Maintenance, see Settings** 72
 - Manual calibration** 112
 - Maximum value** 50
 - MC5P recalibration** 26
 - Measuring**
 - Current 37
 - Frequencies 44
 - General description 33
 - Limit Switch test 42
 - Pressure 35
 - Pulses 45
 - Resistance 40
 - Switch State Detection 41
 - Temperatures (RTD sensor) 46
 - Temperatures (T/C) 47
 - Using the E module 37, 38, 44, 45
 - Using the ET module 38, 40, 46, 47
 - Voltagess 38
 - Menus** 15
 - Min/Max value** 50
 - Minimum value** 50
 - Modules** 20
- O**
- Operational Sections** 4
 - Options** 20, 21

- P**
- Parallel functions in MC5P** 100
 - Percentage** 78
 - Pressure**
 - Module names 92
 - Pressure Types 91
 - Sensor supply 36, 114, 126
 - Square rooting instruments 92
 - Pressure Controllers** 87, 122
 - Pressure measurement** 35
 - Pressure module, zeroing** 36, 80, 81
 - Pressure sensor/transmitter calibration** 114
 - Printer Interface** 7
 - Printing** 13, 89
 - Pulse generation** 61
 - Pulse measurement** 45
- R**
- Ramping** 67
 - Recalibration** 26
 - Redundant measurement** 53
 - Reference Junction**
 - External 47, 63, 94
 - Internal 6, 47, 63, 93
 - Modes 94
 - Module 6
 - Required modules when calibrating an instrument** 106
 - Resistance Measurement** 40
 - Resistance simulation** 62
 - Resolution** 51
 - RTD sensor simulation** 62
- S**
- Saving calibration results** 111
 - Scaling** 77
 - Selecting the instrument to be calibrated** 108
 - Sensor supply** 36, 114, 126
 - Service** 26
 - Settings**
 - Auto-Off Delay 73
 - Date Format 73
 - Display Backlight Brightness 73
 - Language 73
 - Line Frequency 73
 - POC4 87
 - Temperature Scale 73
 - Temperature Unit 73
 - Time and Date 74
 - Time Format 73
 - Use of Environment Sensor 73
 - Volume settings 73
 - Simulating**
 - a Switch 81
 - a Transmitter 80
 - Simulating (see also Generating)**
 - Resistance 62
 - RTD sensors 62
 - Thermocouples 63
 - Simultaneous measurement/generation/simulation** 100
 - Software** 11
 - Special Display Mode** 76
 - Special generations**
 - Ramping 67
 - Stepping 65
 - Special Generations** 65
 - Special measurements** 49
 - Change Rate 50
 - Deviation measurement 51
 - Difference measurement 52
 - Maximum value 50
 - Min/Max value 50
 - Minimum value 50
 - Redundant measurement 53
 - Special Filtering 51
 - Special Resolution 51
 - Starting MC5P** 11, 30
 - Status bar** 14
 - Stepping** 65
 - Support for instrument adjustment** 123
 - Switch Simulation** 79
 - Switch State Sensing** 41
- T**
- Temperature**
 - Controllers** 88, 122
 - Temperature indicator calibration** 118
 - Temperature Measurement**
 - RTD sensor 46
 - Thermocouple 47
 - Temperature recorder calibration** 118
 - Temperature sensor calibration** 116
 - Test Diode, measurement parallel to a** 99
 - Thermocouple simulation** 63
 - Transmitter Simulation** 79
 - Troubleshooting thermocouple measurement** 96
- U**
- Unpacking** 3
 - Updating the firmware** 11
 - Use of Environment Sensor** 73
 - User Interface** 14
- V, W**
- Warnings** 23
 - Viewing angle of the display** 5
 - Viewing Calibration Results** 130
 - Voltage generation** 58
 - Voltage measurement** 38
- Z**
- Zeroing a pressure module** 36, 80, 81